



formalighting

**EVO**

**48V Track System**

**2023 | 24**



# **EVO 48V Track System**

Page 16

**Vivo**

Page 20

**TicTok**

Page 26

**Zero**

Page 36

**Polaris**

Page 42

**Filo**

Page 48

**Pixo Retro**

Page 50

**Pixo**

Page 52

**Lucciole**

# Vivo

## Vivo

Page 16



Ø 75



Ø 58



Ø 45



Ø 35



Ø 25

## Long Arm



## Vivo

Page 18

Ø 75



Ø 58



Ø 45



Ø 35



Ø 25



# TicTok



## TicTok

Page 20

Ø 75



Ø 58



Ø 45



Ø 35



Ø 25



## TicTok Zoom

Page 24

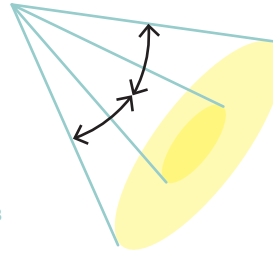

Ø 58



Ø 45



Long Arm



## TicTok

Page 22

Ø 75



Ø 58



Ø 45



Ø 35



Ø 25



Long Arm



## TicTok Zoom

Page 24

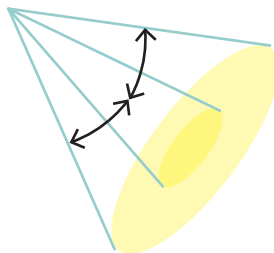

Ø 58



Ø 45



# Zero Framing Projector



## Zero 38 Framing Projector

Page 26



Ø 38

Long Arm



## Zero 38 Framing Projector

Page 26



Ø 38

# Zero

## Zero Compasso Wallwasher

Page 28



## Zero 33

Page 32

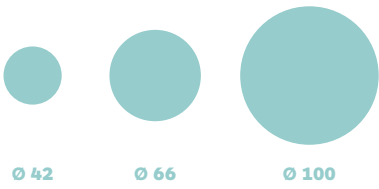

## Long Arm

## Zero Compasso Wallwasher

Page 28



## Zero 33

Page 32

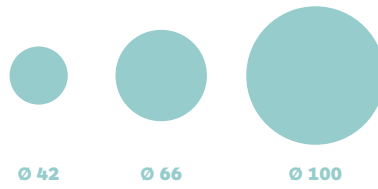

## Long Arm

## Zero

Page 34



## Zero

Page 34

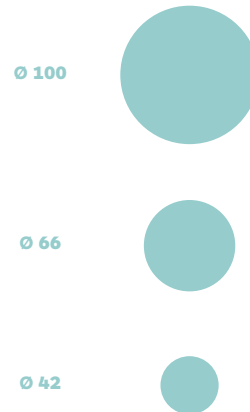



# Polaris



## Polaris 20

Page 44

## Polaris 20

Page 36

## Polaris 20 Wallwasher

Page 36

## Polaris 20 Adjustable

Page 40



## Polaris 20 Opal Diffuser

Page 38

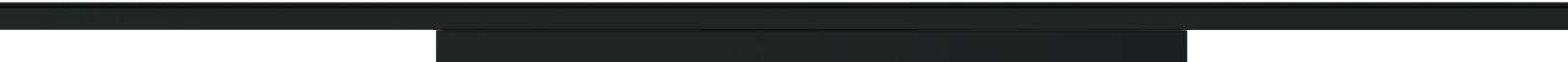

# Filo

Page 42



# Pixo

Page 50

# Pixo Retro

Page 48



Ø 38



Ø 25



Ø 38



Ø 25



# Lucciole

Page 52



# EVO 48V Track Options

Pages 60-65

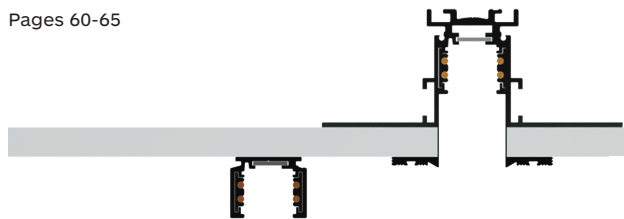

# Power Supply

Page 66



# Mounting Accessories

Page 62

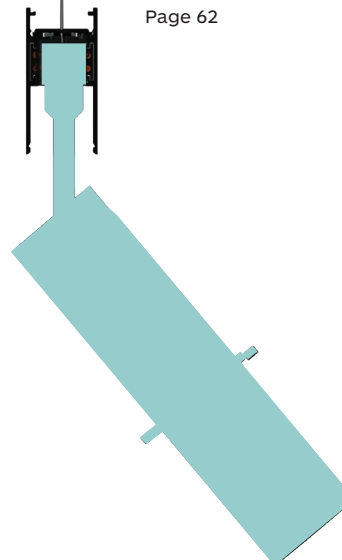

# Code Ordering System

Page 71

# EVO 48V Track, High Performance Luminaires

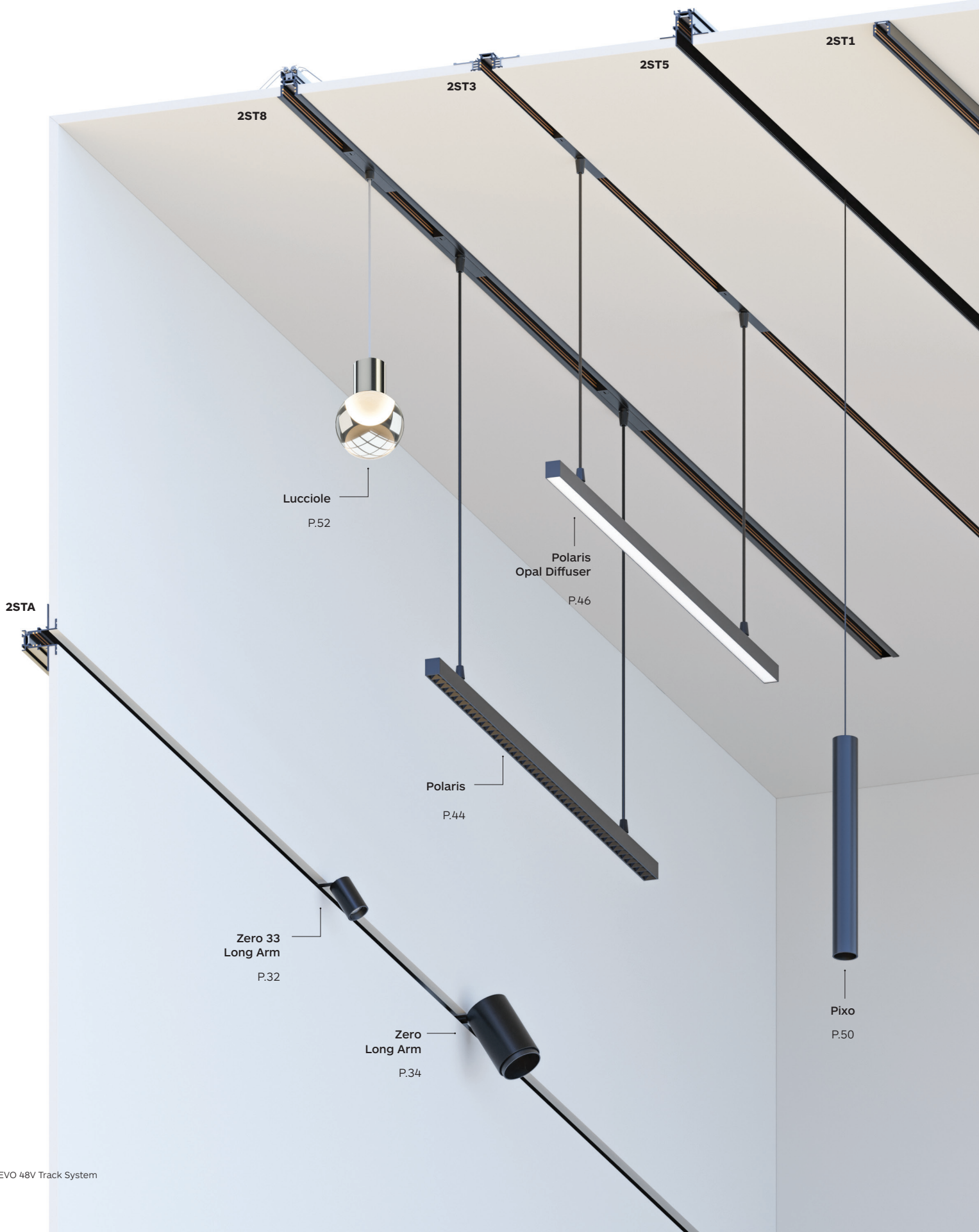

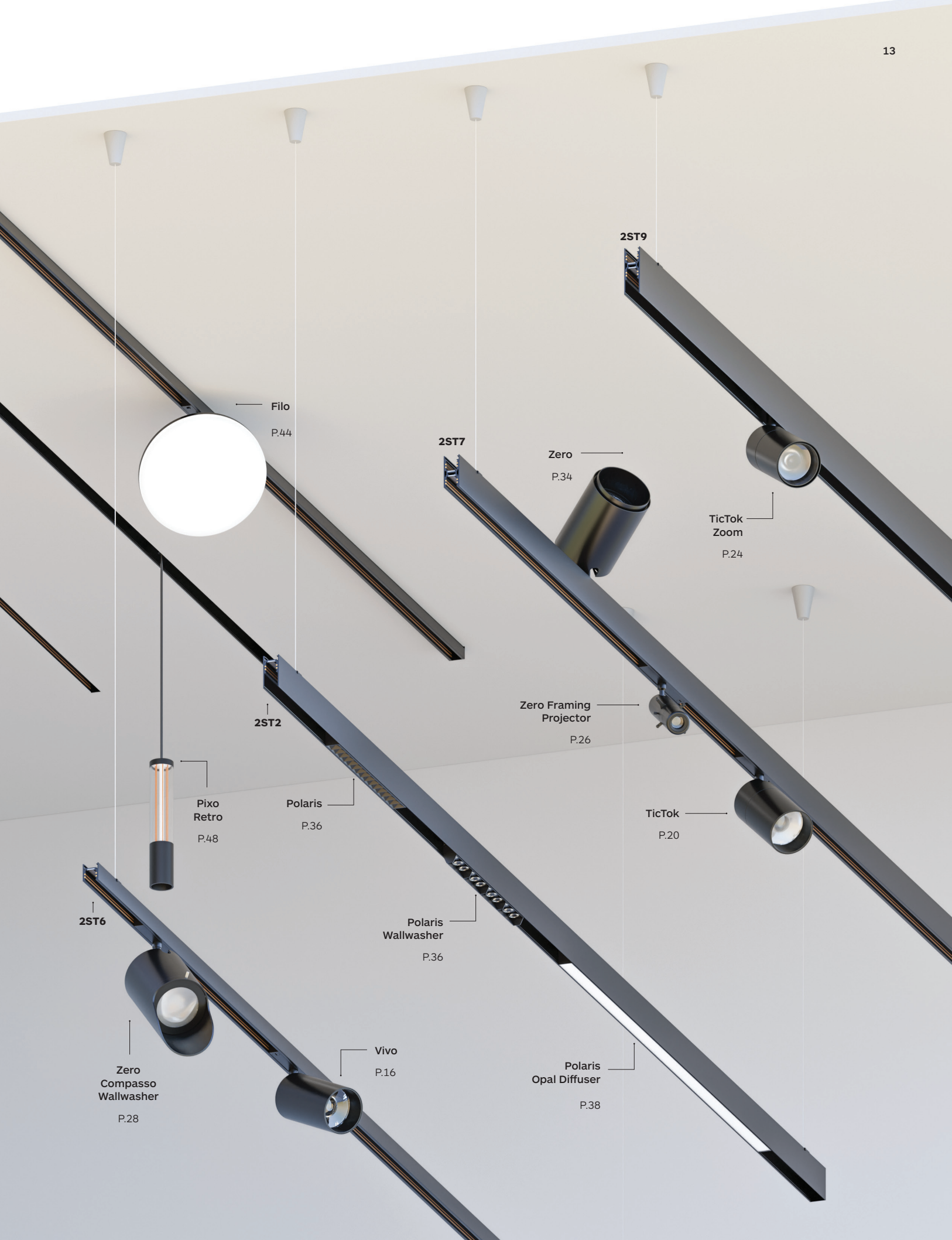

2ST9

Filo  
P.44

2ST7

Zero  
P.34

TicTok  
Zoom  
P.24

2ST2

Zero Framing  
Projector  
P.26

Pixo  
Retro  
P.48

Polaris  
P.36

TicTok  
P.20

2ST6

Polaris  
Wallwasher  
P.36

Zero  
Compasso  
Wallwasher  
P.28

Vivo  
P.16

Polaris  
Opal Diffuser  
P.38



formalighting

**EVO 48V**

**Track System**

formalighting



# Vivo

Designed by Ponctuelle Studio

25 | 35 | 45 | 58 | 75  
EVO 48V Track

- 10 - Black
- 65 - Embossed matt black
- 11 - White
- 54 - Embossed matt white

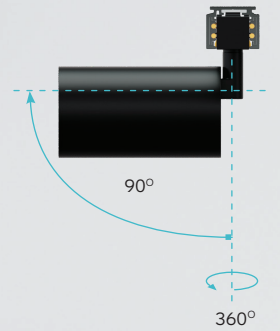

Regular Arm + Regular Track

Vivo enables users to create unique lighting schemes and configurations.

Energy-saving, track mounted on a EVO 48V track system, with integrated driver in the track adaptor - the focus is on eco-friendly design and modularity.

Tool-free interchangeable LED modules facilitate design flexibility and ease of on-site maintenance. Available in five different adjustable light head sizes Ø25, Ø35, Ø45, Ø58 and Ø75mm, with versatile aiming angle tiltable 0°-90° and rotatable 360°.

Available in embossed matt black/white finishing; make it the perfect solution for retail, hospitality, and high-end residences.

Vivo is available with Casambi and DALI control options. DALI dimmable fixtures can also be controlled by Casambi DALI Broadcast device, please see pages 58-59 for details.

For complete code ordering information, please see page 71.



#### LED Sources:

High Efficacy:  
CRI: 90 | CCT: 2700K, 3000K, 3500K, 4000K.  
CRI: 93 | CCT: 2700K, 3000K, 3500K, 4000K.

High Rendering:  
CRI: 98 | CCT: 2700K, 3000K, 3500K, 4000K.

#### Accessories:

- Wide & Dense Texture Honeycomb Louvre
  - Elliptical Beam Diffuser
  - Coloured Glasses Diffuser
  - Opal Lens
  - Spread Lens
  - Cross blade Louvre
  - Barn doors
  - Wallwasher Cone 45°
- Please see page 54 for details.



# Vivo

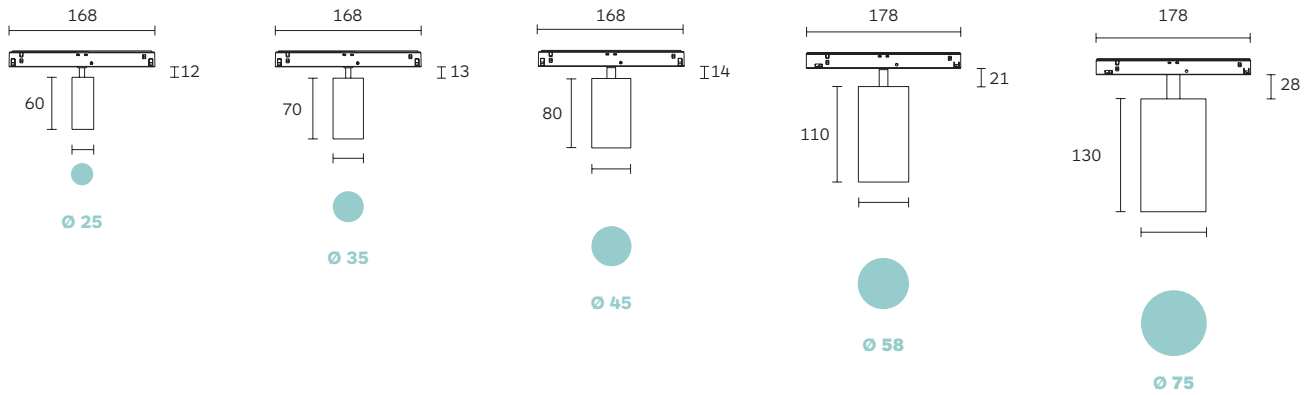
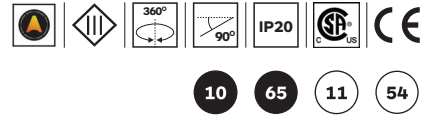





		Product Code	LED Module Code	LED Power	Nominal Lumen	Beam Angle	Dimming Options
<b>CRI &gt; 90</b> <b>3000K</b> <b>High Efficacy</b>	Vivo 25	<b>96A8</b>	<b>E017</b>	3.4W	370 lm	<b>15° / 20° / 32°</b>	<b>D0</b> No Dim <b>DA</b> Dali Dim <b>DC</b> CASAMBI
	Vivo 35	<b>96A9</b>	<b>E013</b>	5W	691 lm	<b>20° / 24° / 38°</b>	<b>CCT Options</b> <b>27</b> 2700K <b>30</b> 3000K <b>35</b> 3500K <b>40</b> 4000K
	Vivo 45	<b>96B0</b>	<b>E025</b>	9W	1208 lm	<b>18° / 28° / 36°</b>	
	Vivo 58	<b>96B1</b>	<b>E031</b>	15W	1740 lm	<b>14° / 24° / 36°</b>	
			<b>E026</b>	14W	1932 lm	<b>18° / 25° / 37°</b>	
Vivo 75	<b>96C7</b>	<b>E029</b>	18W	2305 lm	<b>12° / 26° / 36°</b>		
<b>CRI &gt; 98</b> <b>3000K</b> <b>High Rendering</b>	Vivo 45	<b>96B0</b>	<b>E020</b>	9W	901 lm	<b>18° / 26° / 36°</b>	
	Vivo 58	<b>96B1</b>	<b>E027</b>	14W	1458 lm	<b>18° / 25° / 37°</b>	
	Vivo 75	<b>96C7</b>	<b>E006</b>	18W	1765 lm	<b>14° / 26° / 37°</b>	

# Vivo Long Arm

Designed by Ponctuelle Studio

25 | 35 | 45 | 58 | 75  
EVO 48V Track

-  10 - Black
-  65 - Embossed matt black
-  11 - White
-  54 - Embossed matt white

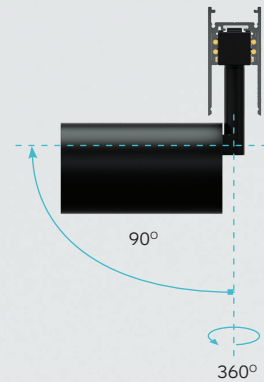

Long Arm + Deep Track

Vivo Long Arm is designed for deep recessed and pendant EVO 48V track applications. Energy-saving, track mounted on a EVO 48V track system, with integrated driver in the track adaptor - the focus is on eco-friendly design and modularity.

Tool-free interchangeable LED modules facilitate design flexibility and ease of on-site maintenance. Available in five different adjustable light head sizes  $\varnothing 25$ ,  $\varnothing 35$ ,  $\varnothing 45$ ,  $\varnothing 58$  and  $\varnothing 75$ mm, with versatile aiming angle tiltable  $0^\circ$ - $90^\circ$  and rotatable  $360^\circ$ .

Available in embossed matt black/white finishing; make it the perfect solution for retail, hospitality, and high-end residences.

Vivo Long Arm is available with Casambi and DALI control options. DALI dimmable fixtures can also be controlled by Casambi DALI Broadcast device, please see pages 58-59 for details.

For complete code ordering information, please see page 71.



#### LED Sources:

High Efficacy:  
CRI: 90 | CCT: 2700K, 3000K, 3500K, 4000K.  
CRI: 93 | CCT: 2700K, 3000K, 3500K, 4000K.

High Rendering:  
CRI: 98 | CCT: 2700K, 3000K, 3500K, 4000K.

#### Accessories:

- Wide & Dense Texture Honeycomb Louvre
  - Elliptical Beam Diffuser
  - Coloured Glasses Filters
  - Opal Lens
  - Spread Lens
  - Cross blade Louvre
  - Barn doors
  - Wallwasher Cone  $45^\circ$
- Please see page 54 for details.

# Vivo Long Arm

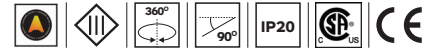

10 65 11 54

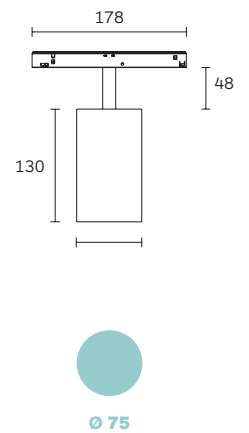
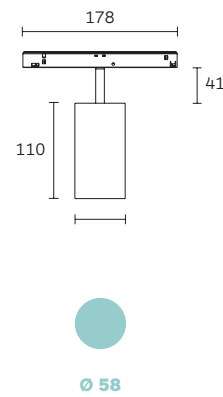
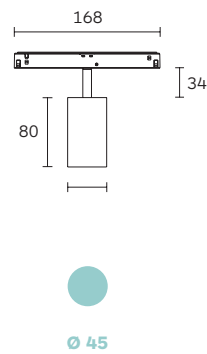
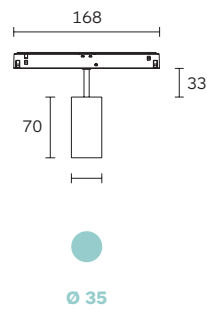
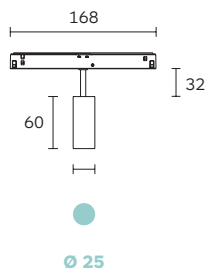

**CRI > 90**  
**3000K**  
**High Efficacy**

		Product Code	LED Module Code	LED Power	Nominal Lumen	Beam Angle	Dimming Options
Vivo 25	<b>96C8</b>	<b>E017</b>	3.4W	370 lm	<b>15° / 20° / 32°</b>	<b>D0</b> No Dim <b>DA</b> Dali Dim <b>DC</b> CASAMBI	

**CRI > 93**  
**3000K**  
**High Efficacy**

						CCT Options
Vivo 35	<b>96C9</b>	<b>E013</b>	5W	691 lm	<b>20° / 24° / 38°</b>	<b>27</b> 2700K
Vivo 45	<b>96D0</b>	<b>E025</b>	9W	1208 lm	<b>18° / 28° / 36°</b>	<b>30</b> 3000K
Vivo 58	<b>96D1</b>	<b>E031</b>	15W	1740 lm	<b>14° / 24° / 36°</b>	<b>35</b> 3500K
		<b>E026</b>	14W	1932 lm	<b>18° / 25° / 37°</b>	<b>40</b> 4000K
Vivo 75	<b>96D2</b>	<b>E029</b>	18W	2305 lm	<b>12° / 26° / 36°</b>	

**CRI > 98**  
**3000K**  
**High Rendering**

Vivo 45	<b>96D0</b>	<b>E020</b>	9W	901 lm	<b>18° / 26° / 36°</b>
Vivo 58	<b>96D1</b>	<b>E027</b>	14W	1458 lm	<b>18° / 25° / 37°</b>
Vivo 75	<b>96D2</b>	<b>E006</b>	18W	1765 lm	<b>14° / 26° / 37°</b>

# TicTok

25 | 35 | 45 | 58 | 75  
EVO 48V Track



- 10 - Black
- 65 - Embossed matt black
- 11 - White
- 54 - Embossed matt white

TicTok enables users to create unique lighting schemes and configurations.

Energy-saving, track mounted on a EVO 48V track system, with integrated driver in the track adaptor - the focus is on eco-friendly design and modularity.

TicTok's tool-free interchangeable LED module facilitates design flexibility and ease of on-site maintenance. Available in five different adjustable light head sizes Ø25, Ø35, Ø45, Ø58 and Ø75mm, with versatile aiming angle tiltable 0°-70° and rotatable 360°.

Designed to be the perfect solution for accent lighting in sustainable lighting design schemes for retail, hospitality and high-end residences. A ready-to-use solution for greater flexibility, energy efficiency, and sustainability.

TicTok is available with Casambi or DALI control options. DALI dimmable fixtures can also be controlled by Casambi DALI Broadcast device, please see pages 58-59 for details.

For complete code ordering information, please see page 71.

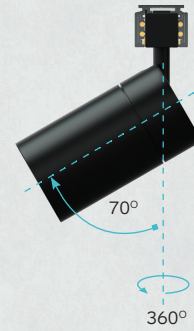

Regular Arm + Regular Track



#### LED Sources:

High Efficacy:  
CRI: 90 | CCT: 2700K, 3000K, 3500K, 4000K.  
CRI: 93 | CCT: 2700K, 3000K, 3500K, 4000K.

High Rendering:  
CRI: 98 | CCT: 2700K, 3000K, 3500K, 4000K.

#### Accessories:

- Wide & Dense Texture Honeycomb Louvre
  - Elliptical Beam Diffuser
  - Coloured Glasses Diffuser
  - Opal Lens
  - Spread Lens
  - Cross blade Louvre
  - Barn doors
  - Wallwasher Cone 45°
- Please see page 54 for details.

# TicTok

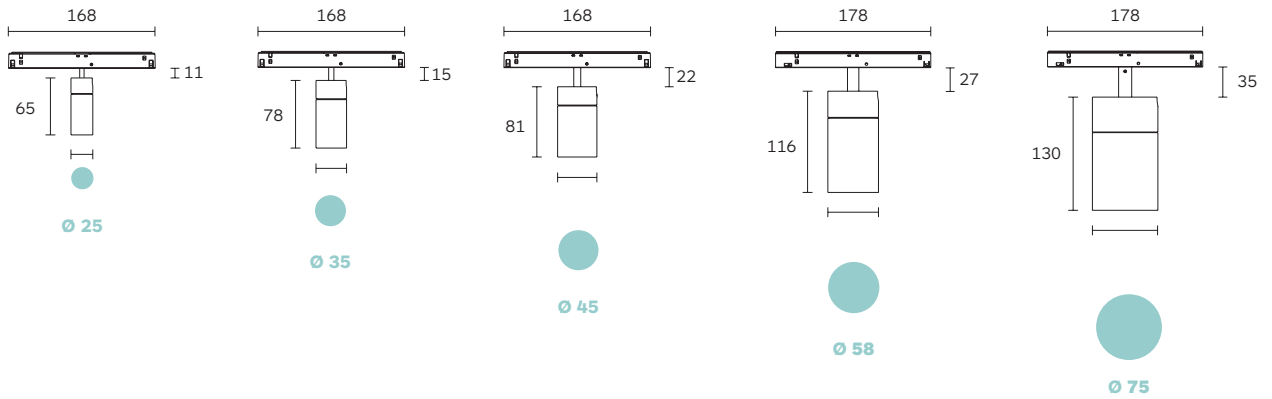
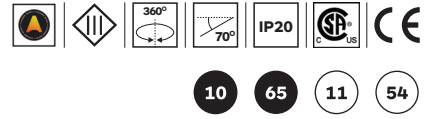

		Product Code	LED Module Code	LED Power	Nominal Lumen	Beam Angle	Dimming Options
<b>CRI &gt; 90</b> <b>3000K</b> <b>High Efficacy</b>	TicTok 25	<b>96B2</b>	<b>E017</b>	3.4W	370 lm	<b>15° / 20° / 32°</b>	<b>D0</b> No Dim <b>DA</b> Dali Dim <b>DC</b> CASAMBI
<b>CRI &gt; 93</b> <b>3000K</b> <b>High Efficacy</b>	TicTok 35	<b>96B3</b>	<b>E013</b>	5W	691 lm	<b>20° / 24° / 38°</b>	<b>CCT Options</b> <b>27</b> 2700K <b>30</b> 3000K <b>35</b> 3500K <b>40</b> 4000K
	TicTok 45	<b>9662</b>	<b>E025</b>	9W	1208 lm	<b>18° / 28° / 36°</b>	
	TicTok 58	<b>9664</b>	<b>E031</b>	15W	1740 lm	<b>14° / 24° / 36°</b>	
			<b>E026</b>	14W	1932 lm	<b>18° / 25° / 37°</b>	
	TicTok 75	<b>9666</b>	<b>E029</b>	18W	2305 lm	<b>12° / 26° / 36°</b>	
<b>CRI &gt; 98</b> <b>3000K</b> <b>High Rendering</b>	TicTok 45	<b>9662</b>	<b>E020</b>	9W	901 lm	<b>18° / 28° / 36°</b>	
	TicTok 58	<b>9664</b>	<b>E027</b>	14W	1458 lm	<b>18° / 25° / 37°</b>	
	TicTok 75	<b>9666</b>	<b>E006</b>	18W	1765 lm	<b>14° / 26° / 37°</b>	

# TicTok Long Arm

25 | 35 | 45 | 58 | 75  
EVO 48V Track



- 10 - Black
- 65 - Embossed matt black
- 11 - White
- 54 - Embossed matt white

TicTok Long Arm is designed for deep recessed and pendant EVO 48V track applications.

TicTok focus on eco-friendly design and modularity.

TicTok's tool-free, and interchangeable LED module facilitates design flexibility and ease of on-site maintenance. Available in five different adjustable light head sizes Ø25, Ø35, Ø45, Ø58 and Ø75mm, with versatile aiming angle tiltable 0°-70° and rotatable 360°.

Perfect solution for accent lighting in sustainable lighting design schemes for retail, hospitality and high-end residences. A ready-to-use solution for greater flexibility, energy efficiency, and sustainability.

TicTok is available with Casambi or DALI control options. DALI dimmable fixtures can also be controlled by Casambi DALI Broadcast device, please see pages 58-59 for details.

For complete code ordering information, please see page 71.

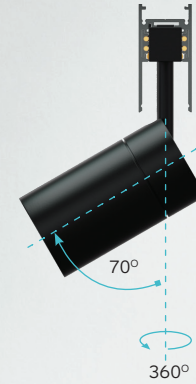

Long Arm + Deep Track



#### LED Sources:

High Efficacy:  
CRI: 90 | CCT: 2700K, 3000K, 3500K, 4000K.  
CRI: 93 | CCT: 2700K, 3000K, 3500K, 4000K

High Rendering:  
CRI: 98 | CCT: 2700K, 3000K, 3500K, 4000K

#### Accessories:

- Wide & Dense Texture Honeycomb Louvre
  - Elliptical Beam Diffuser
  - Coloured Glasses Diffuser
  - Opal Lens
  - Spread Lens
  - Cross blade Louvre
  - Barn doors
  - Wallwasher Cone 45°
- Please see page 54 for details.

# TicTok Long Arm

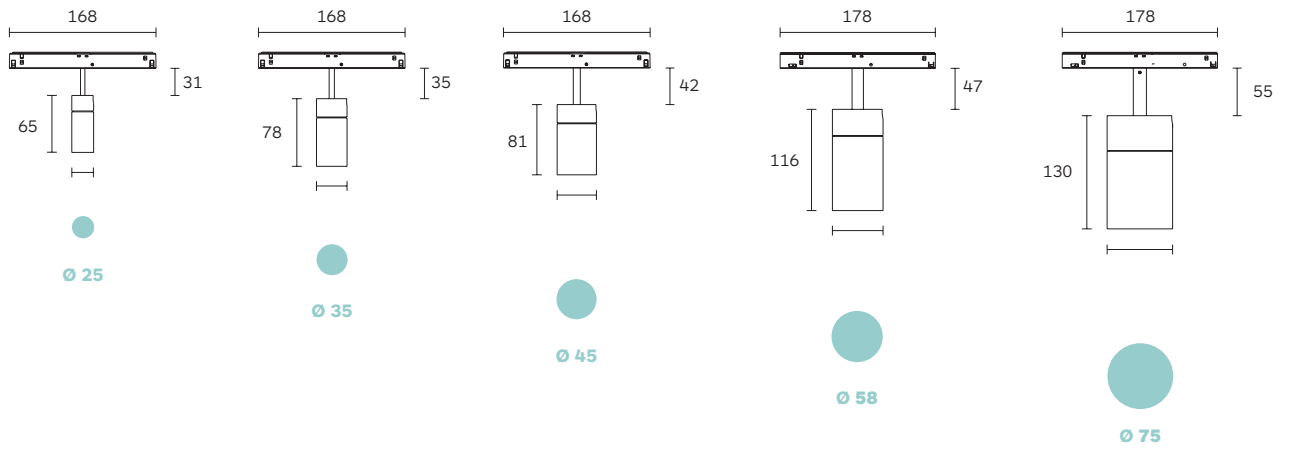

	Product Code	LED Module Code	LED Power	Nominal Lumen	Beam Angle	Dimming Options	
<b>CRI &gt; 90</b> <b>3000K</b> <b>High Efficacy</b>	TicTok 25	<b>96C3</b>	<b>E017</b>	3.4W	370 lm	<b>15° / 20° / 32°</b>	<b>D0</b> No Dim <b>DA</b> Dali Dim <b>DC</b> CASAMBI
	TicTok 35	<b>96C4</b>	<b>E013</b>	5W	691 lm	<b>20° / 24° / 38°</b>	<b>CCT Options</b> <b>27</b> 2700K <b>30</b> 3000K <b>35</b> 3500K <b>40</b> 4000K
<b>CRI &gt; 93</b> <b>3000K</b> <b>High Efficacy</b>	TicTok 45	<b>9663</b>	<b>E025</b>	9W	1208 lm	<b>18° / 28° / 36°</b>	
	TicTok 58	<b>9665</b>	<b>E031</b>	15W	1740 lm	<b>14° / 24° / 36°</b>	
			<b>E026</b>	14W	1932 lm	<b>18° / 25° / 37°</b>	
	TicTok 75	<b>9667</b>	<b>E029</b>	18W	2305 lm	<b>12° / 26° / 36°</b>	
<b>CRI &gt; 98</b> <b>3000K</b> <b>High Rendering</b>	TicTok 45	<b>9663</b>	<b>E020</b>	9W	901 lm	<b>18° / 28° / 36°</b>	
	TicTok 58	<b>9665</b>	<b>E027</b>	14W	1458 lm	<b>18° / 25° / 37°</b>	
	TicTok 75	<b>9667</b>	<b>E006</b>	18W	1765 lm	<b>14° / 26° / 37°</b>	

# TicTok Zoom

45 | 58  
EVO 48V Track



- 10 - Black
- 65 - Embossed matt black
- 11 - White
- 54 - Embossed matt white

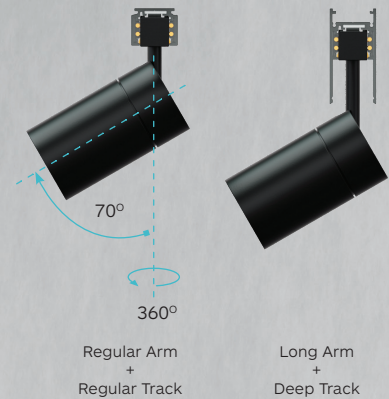

TicTok Zoom focus on eco-friendly design and modularity. TicTok Zoom tool-free interchangeable LED module facilitates design flexibility and ease of on-site maintenance.

Available in Ø45 and Ø58mm, with versatile aiming angle tiltable 0°-70° and rotatable 360°. The beam angle is manually adjustable through ring rotation, from 10° to 38°. It is available in standard surface, deep recessed, and pendant EVO 48V track applications.

A ready-to-use solution for greater flexibility, energy efficiency, and sustainability.

TicTok is available with Casambi or DALI control options. DALI dimmable fixtures can also be controlled by Casambi DALI Broadcast device, please see pages 58-59 for details.

For complete code ordering information, please see page 71.



#### LED Sources:

High Efficacy:  
CRI: 90 | CCT: 2700K, 3000K, 3500K, 4000K.  
CRI: 93 | CCT: 2700K, 3000K, 3500K, 4000K.

#### Accessories:

For more information about EVO 48V track accessories see pages 60-65.



# TicTok Zoom

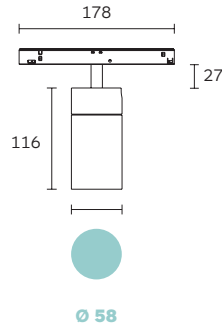
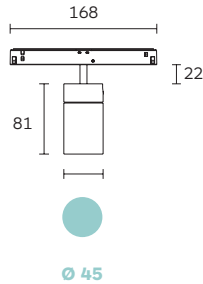
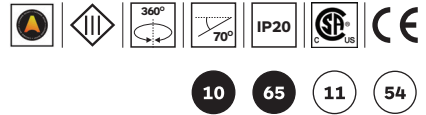

Long Arm

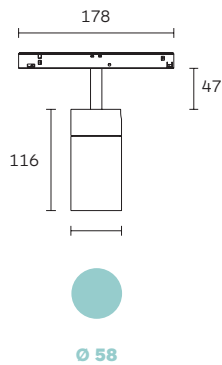
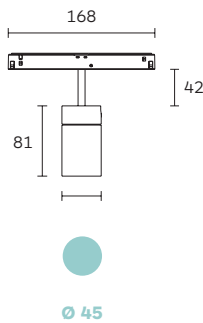

## Zoom Spotlights

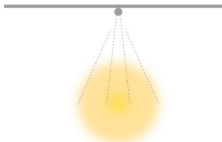

Zoom Spot 12° - 37°

		Product Code	LED Module Code	LED Power	Nominal Lumen	Beam Angle	Dimming Options	CCT Options
<b>CRI&gt;90</b> <b>3000K</b> <b>High Efficacy</b>	TicTok Zoom 45	<b>96A6</b>	<b>E009</b>	6W	549 lm	<b>BS</b> (12°-37°)	<b>D0</b> No Dim	<b>27</b> 2700K
	TicTok Zoom 45 Long Arm	<b>96C5</b>					<b>DA</b> Dali Dim	<b>30</b> 3000K
							<b>DC</b> CASAMBI	<b>35</b> 3500K
							<b>DN</b> On-board Dimmer	<b>40</b> 4000K
<b>CRI&gt;93</b> <b>3000K</b> <b>High Efficacy</b>	TicTok Zoom 58	<b>96A7</b>	<b>E004</b>	15W	1635 lm	<b>BS</b> (17°-27°)		
	TicTok Zoom 58 Long Arm	<b>96C6</b>						

# Zero 38 Framing Projector

EVO 48V Track

- 10 - Black
- 65 - Embossed matt black
- 11 - White
- 54 - Embossed matt white

Zero 38 framing projector is an advanced, multi-functional EVO 48V track-mounted projector, tiltable vertically 0°-90° and rotatable horizontally 350°. With built-in bidirectional zooming lens with sharpness adjustability, and lens rotation. Available in regular and long arm version for deep recessed and pendant EVO 48V track.

Fully adjustable shutters to reframe the beam to the desired size and shape (circle, square/rectangle, or irregular four-sided shapes). Compatible with Gobo insertion for logo. High-precision optics for sharp outlines and a high degree of lighting uniformity.

Zero 38 framing projector is available with Casambi or DALI control options. DALI dimmable fixtures can also be controlled by Casambi DALI Broadcast device, please see pages 58-59 for details.

For complete code ordering information, please see page 71.

#### LED Sources:

High Rendering:  
CRI: 97 | CCT: 2700K, 3000K, 3500K, 4000K.

#### Accessories:

- Gobo Film, see page 55 for details  
Contact us for custom-made logo projection lens.



# Zero 38 Framing Projector

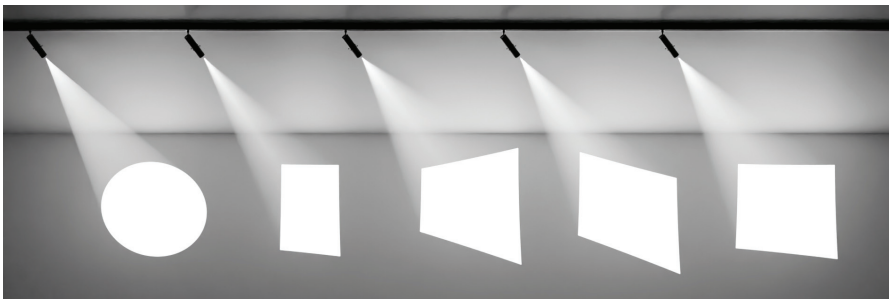
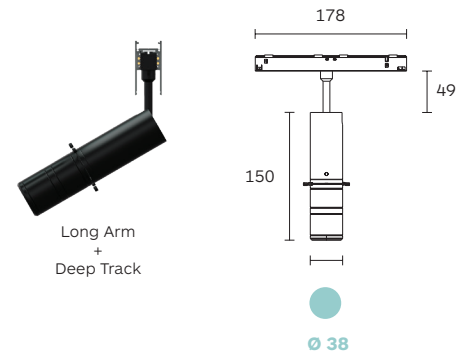
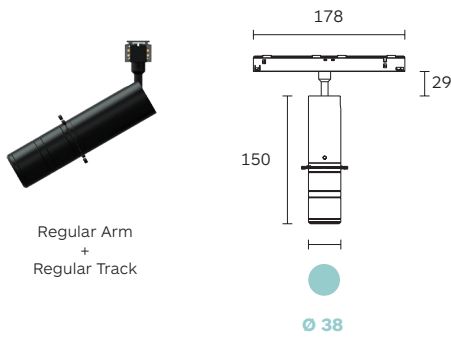
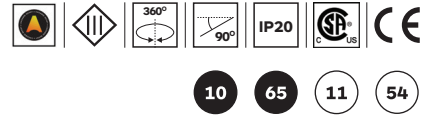

Recommended distance from fixture to wall between 0.5metres to 10metres.



Gobo Film logo projector lens.  
Accessory Art. 2G24

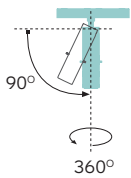

**CRI>97**  
**3000K**

**High**  
**Rendering**

Zero 38 Framing Projector  
Zero 38 Framing Projector  
Long Arm

Product Code  
**96A4**  
**96A5**

LED Source Code  
**BC42**

LED Power  
9.6W

Nominal Lumen  
848 lm

Beam Angle  
**BS (14°-35°)**

Dimming Options

**DO** No Dim  
**DA** Dali Dim  
**DC** CASAMBI

CCT Options

**27** 2700K  
**30** 3000K  
**35** 3500K  
**40** 4000K

# Zero Compasso Wallwasher

42 | 66 | 100  
EVO 48V Track

- 10 - Black
- 65 - Embossed matt black
- 11 - White
- 54 - Embossed matt white

EVO 48V track mounted Zero Compasso wallwasher, available in three sizes (Ø42, Ø66 and Ø100mm) versatile aiming angle tiltable vertically 0°-90° and rotatable horizontally 360°. Available in regular and long arm version for deep recessed and pendant EVO 48V track.

Perfect for museums and galleries applications. Wallwashing with high uniformity can be used to illuminate artwork and sculptures. Vertical uniformity creates a wide and distinguished spatial impression by brightening the entire height of the wall.

DALI dimmable fixtures can also be controlled by Casambi DALI Broadcast device, please see pages 58-59 for details.

For complete code ordering information, please see page 71.

#### LED Sources:

High Rendering:  
CRI: 97 | CCT: 2700K, 3000K, 3500K, 4000K.

#### Accessories:

For more information about EVO 48V track accessories see pages 60-65.

# Zero Compasso Wallwasher

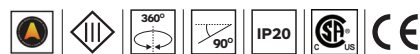

Regular Arm + Regular Track

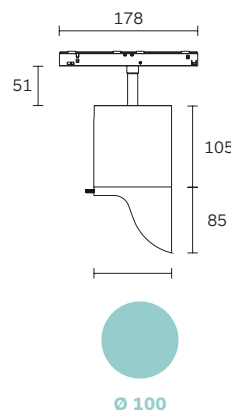
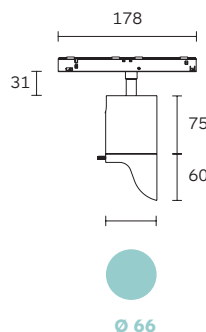
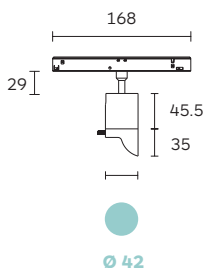

## Long Arm



Long Arm + Deep Track

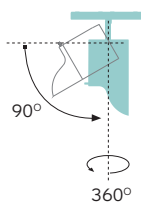
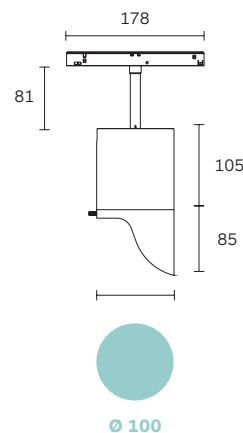
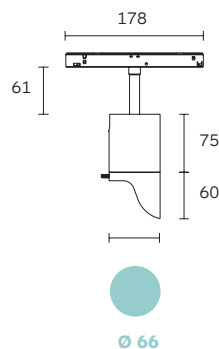
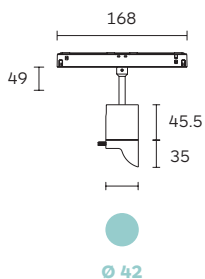

**CRI >90**  
**3000K**

**High Efficacy**

**CRI >97**  
**3000K**

**High Rendering**

Zero Compasso 42 Wallwasher  
Zero Compasso 42 Wallwasher Long Arm

Product Code

LED Module Code

LED Power

Nominal Lumen

Beam Angle

Dimming Options

CCT Options

**9673**

**BR21**

4W

439 lm

**WW**

**DO** No Dim

**27** 2700K

**96E5**

**DA** Dali Dim

**30** 3000K

**DC** CASAMBI

**35** 3500K

**40** 4000K

Zero Compasso 66 Wallwasher **9671** **BC22** 12W 1550 lm

Zero Compasso 66 Wallwasher Long Arm **96E6**

Zero Compasso 100 Wallwasher **9672** **BC33** 14W 1789 lm

Zero Compasso 100 Wallwasher Long Arm **96E7**

WW = Wallwasher. Ordering code: **WW**.



# Zero Compasso Wallwasher

## Lighting Effects



Zero Compasso 66 Wallwasher

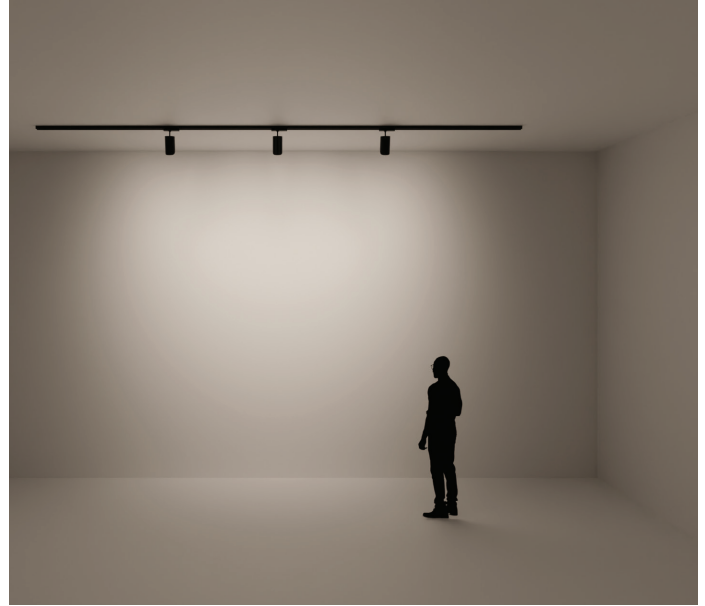

Zero Compasso 100 Wallwasher

### Example of a wallwasher table

Illuminances 1x (Wall)

	Zero Compasso 66 Wallwasher				Zero Compasso 100 Wallwasher			
Angle of tilt ( $\alpha$ )	10°				0°			
Wall Height (m)	3				4			
Wall Width (m)	7				7			
Offset from Wall y	1.00	1.25	1.50	1.50	1.00	1.25	1.50	1.50
Luminaire spacing (m) x	0.83	1.00	1.25	1.50	1.00	1.25	1.50	1.50
Illuminance (lx) Average	141	117	105	78	126	105	93	70
Illuminance (lx) Max	242	201	180	134	223	186	165	124

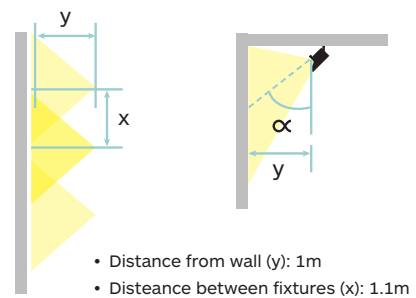

#### Luminaire spacing

The luminaire spacing (x) for some wallwashers can vary by up to 1.5 times the wall offset (y). Corresponding details are provided in the wallwasher table in catalog datasheets. Computerized beam calculations are recommended to check potential intersections with side walls.

#### Wallwasher angle of tilt

The lens wallwasher requires tilting. The product data sheet specifies the optimal tilt angle ( $\alpha$ ) for uniform light distribution on the wall.

# Zero 33

## EVO 48V Track

Zero 33 miniature design track spot projector with high lumen intensity values. Available in regular and long arm versions for deep recessed and pendant EVO 48V track.

Featuring an onboard beam angle adjustment (8-80°) to resolve the most complex focal points and dimming control (1-100%) to adjust the light's intensity while remaining invisible from short distances. Fully adjustable vertically tiltable 0°-90° and rotatable horizontally 330°.

Optical accessories are easy to install with a unique magnet system. DALI dimmable fixtures can also be controlled by Casambi DALI Broadcast device, please see pages 58-59 for details.

For complete code ordering information, please see page 71.

### LED Sources:

High Efficacy:  
CRI: 90 | CCT: 2700K, 3000K, 3500K, 4000K.

### Accessories:

- Honeycomb Louvre
  - Diffuser
  - Barn doors
- Please see page 55 for details.

● 10 - Black

● 65 - Embossed matt black

○ 11 - White

○ 54 - Embossed matt white



# Zero 33

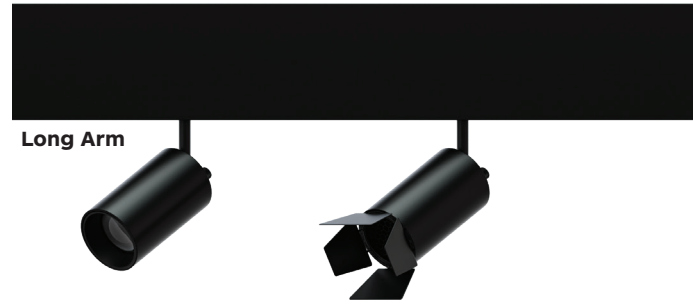
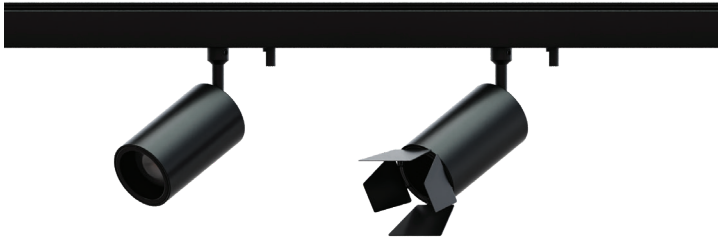
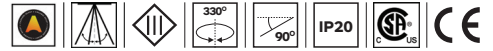

Regular Arm + Regular Track

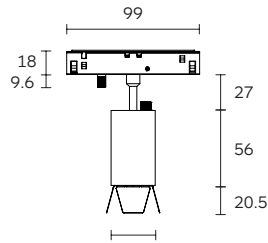

Long Arm + Deep Track

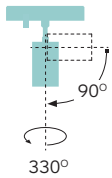
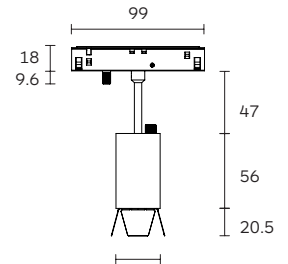

## Zoom Spotlights



Zoom Spot 8° - 80°

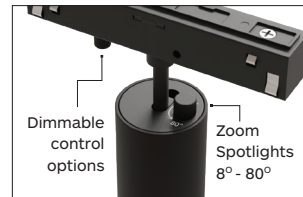

**CRI > 90**  
**3000K**

**High Efficacy**

	Product Code	LED Source Code	LED Power	Nominal Lumen	Beam Angle	Dimming Options	CCT Options
Zero 33	<b>9648</b>	<b>BR21</b>	4.5W	487 lm	<b>BS</b> (8-80°)	<b>D0</b> No Dim	<b>27</b> 2700K
Zero 33 Long Arm	<b>9649</b>					<b>DA</b> Dali Dim	<b>30</b> 3000K
						<b>DC</b> CASAMBI	<b>35</b> 3500K
						<b>DN</b> On-board Dimmer	<b>40</b> 4000K

# Zero

40 | 66 | 100  
EVO 48V Track



- 10 - Black
- 65 - Embossed matt black
- 11 - White
- 54 - Embossed matt white

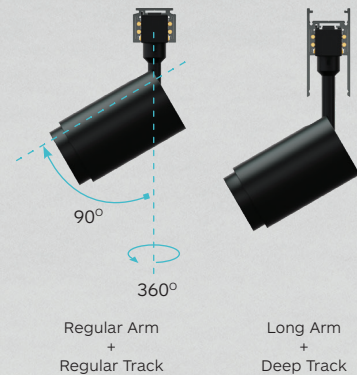

Zero compact aluminum housing designed for passive cooling. It is available in regular arm and long arm versions for deep recessed and pendant EVO 48V track.

Integrated dimmable driver in EVO 48V track adapter, available in Casambi or DALI control options. Available in three different sizes Ø40, Ø66, Ø100mm. Versatile aiming angle tiltable vertically 0°-90° and rotatable horizontally 360°.

DALI dimmable fixtures can also be controlled by Casambi DALI Broadcast device, please see pages 58-59 for details.

For complete code ordering information, please see page 71.

#### LED Sources:

High Efficacy:  
CRI: 90 | CCT: 2700K, 3000K, 3500K, 4000K,  
Tuneable White.

#### Accessories:

- Coloured Glasses Diffuser
  - Linear Spread
  - Honeycomb Louvre
  - Visor
  - Anti-Glare Tube
- Please see page 55 for details.

# Zero

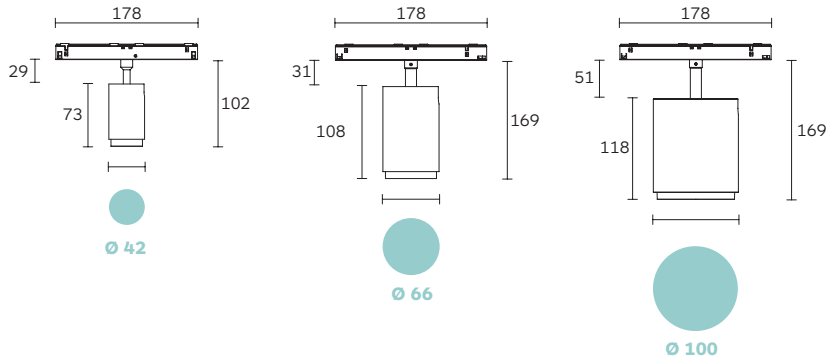
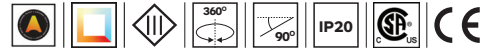

## Long Arm

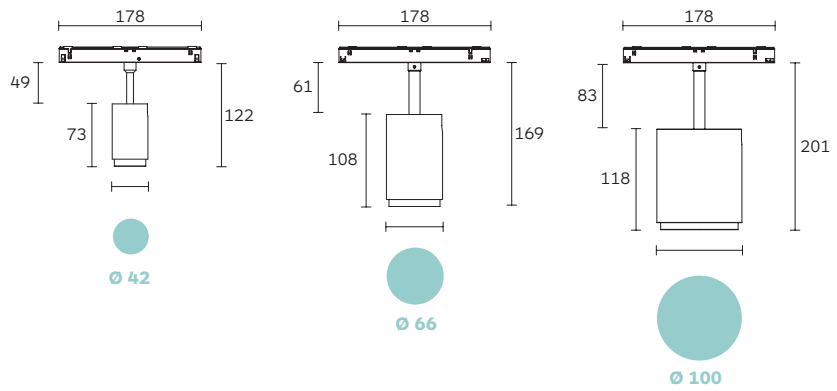

**CRI > 90**  
**3000K**

**High Efficacy**

	Product Code	LED Source Code	LED Power	Nominal Lumen	Beam Angle	Dimming Options	CCT Options
Zero 40	<b>9614</b>	<b>BR21</b>	4W	439 lm	<b>07°</b>	<b>D0</b> No Dim	<b>27</b> 2700K
Zero 40 Long Arm	<b>9631</b>	<b>BC31</b>	6W	705 lm	<b>16° / 26° / 36°</b>	<b>DA</b> Dali Dim	<b>30</b> 3000K
		<b>BU11 (T2*)</b>	7W	831 lm	<b>26° / 32°</b>	<b>DC</b> CASAMBI	<b>35</b> 3500K
							<b>40</b> 4000K
Zero 66	<b>9615</b>	<b>BR21</b>	6W	574 lm	<b>05°</b>		<b>*T2</b> 2700K-6500K
Zero 66 Long Arm	<b>9632</b>	<b>BC22</b>	12W	1550 lm	<b>16° / 25° / 36°</b>		
		<b>BC31</b>	11W	1160 lm	<b>11° / 16° / 32°</b>		
		<b>IU21 (T2*)</b>	13W	1482 lm	<b>24° / 30° / 43°</b>		
Zero 100	<b>9616</b>	<b>BR21</b>	16W	1756 lm	<b>07°</b>		
Zero 100 Long Arm	<b>9634</b>	<b>BC33</b>	21W	2569 lm	<b>15° / 24° / 38°</b>		
		<b>BB31 (T2*)</b>	21W	2411 lm	<b>18° / 26° / 34°</b>		

T2 = Tuneable White

# Polaris

20 | 20 Wallwasher  
EVO 48V Track

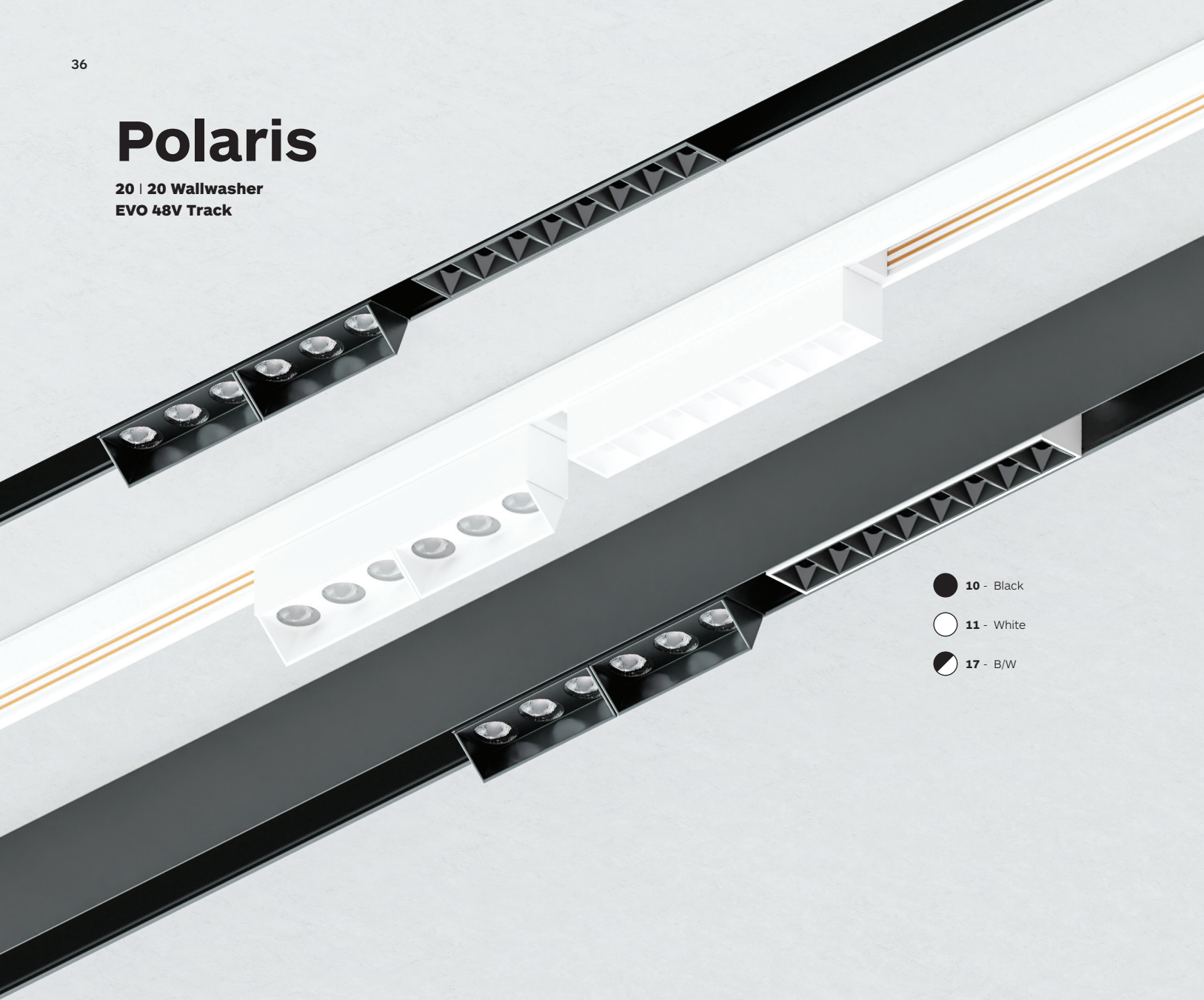

- 10 - Black
- 11 - White
- ◐ 17 - B/W

Polaris 20 and Polaris 20 wallwasher compact design linear spotlight, for EVO 48V track and deep recessed track.

The standard version is inclusive of an Integrated diamond faceted no-dazzle screen in thermoplastic. The wallwasher version is inclusive of the integrated louvre.

Integrated track adapter, compatible with different models of EVO 48V track system. Easy to insert and remove from the track. Available in different configurations.

DALI dimmable fixtures can also be controlled by Casambi DALI Broadcast device, please see pages 58-59 for details.

For complete code ordering information, please see page 71.

#### LED Sources:

High Rendering:  
CRI: 97 | CCT: 2700K, 3000K, 3500K, 4000K.

#### Accessories:

For more information about EVO 48V track accessories see pages 60-65.

# Polaris 20 & Polaris 20 Wallwasher

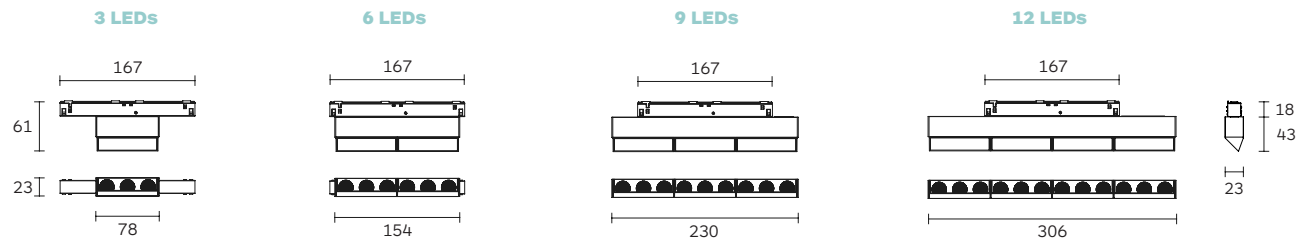
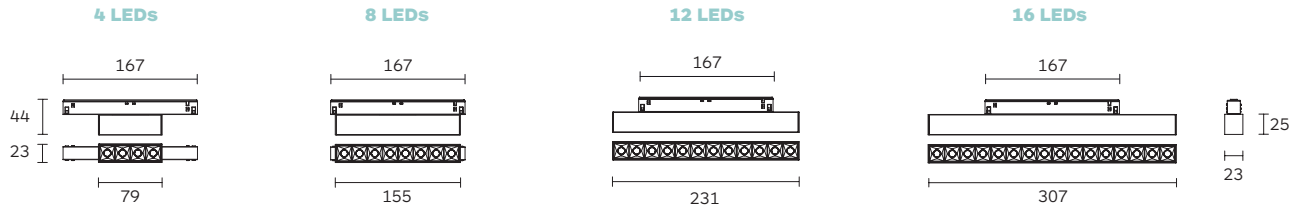

	Product Code	LED Source Code	LED Power	Nominal Lumen	Beam Angle	Dimming Options
<b>CRI&gt;97</b> <b>3000K</b> <b>High Rendering</b>	Polaris 20 with 4 LEDs	<b>9601</b>	<b>BO11</b>	4x1W	<b>21° / 33° / 45° / 60° / EL</b>	<b>D0</b> No Dim
	Polaris 20 with 8 LEDs	<b>9602</b>		8x1W		<b>DA</b> Dali Dim
	Polaris 20 with 12 LEDs	<b>9603</b>		12x1W		<b>DC</b> CASAMBI
	Polaris 20 with 16 LEDs	<b>9604</b>		16x1W		
	Polaris 20 Wallwasher with 3 LEDs	<b>9626</b>	<b>BN11</b>	3x1W	<b>WW</b>	CCT Options
	Polaris 20 Wallwasher with 6 LEDs	<b>9627</b>		6x1W		<b>27</b> 2700K
	Polaris 20 Wallwasher with 9 LEDs	<b>9628</b>		9x1W		<b>30</b> 3000K
	Polaris 20 Wallwasher with 12 LEDs	<b>9629</b>		12x1W		<b>35</b> 3500K <b>40</b> 4000K

EL = Elliptical Beam. Ordering code; **EL**.  
 WW = Wallwasher. Ordering code; **WW**.  
 Tuneable White (**TW**) version available on request.

# Polaris 20 Opal Diffuser

EVO 48V Track



Track mounted EVO 48V spotlight with light body in extruded aluminium inclusive of white opal diffuser for soft and diffuse illumination.

Integrated track adapter, compatible with different models of EVO 48V track system.

Easy to insert and remove from the track.

DALI dimmable fixtures can also be controlled by Casambi DALI Broadcast device, please see pages 58-59 for details.

For complete code ordering information, please see page 71.

#### LED Sources:

High Rendering:  
CRI: 97 | CCT: 2700K, 3000K, 3500K, 4000K.

#### Accessories:

For more information about EVO 48V track accessories see pages 60-65.

# Polaris 20 Opal Diffuser

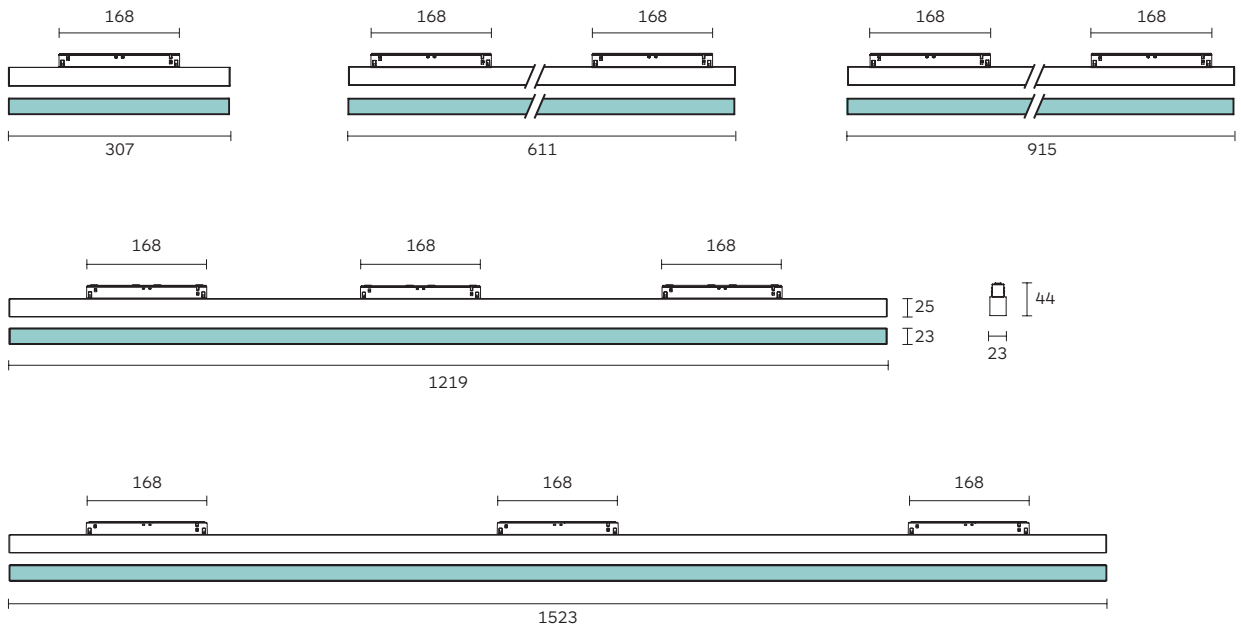

**CRI > 97**  
**3000K**

**High Rendering**

	Product Code	LED Source Code	LED Power	Nominal Lumen	Diffuser	Dimming Options	CCT Options
Polaris 20 Opal Diffuser L:307	<b>9676</b>	<b>BT21</b>	7.4W	945 lm	<b>OD</b>	<b>DO</b> No Dim	<b>27</b> 2700K
Polaris 20 Opal Diffuser L:611	<b>9677</b>		15W	1890 lm		<b>DA</b> Dali Dim	<b>30</b> 3000K
Polaris 20 Opal Diffuser L:915	<b>9678</b>		22W	2835 lm		<b>DC</b> CASAMBI	<b>35</b> 3500K
Polaris 20 Opal Diffuser L:1219	<b>9679</b>		30W	2780 lm			<b>40</b> 4000K
Polaris 20 Opal Diffuser L:1523	<b>9680</b>		37W	4725 lm			<b>TW</b> 2700K-5700K

OD = Opal diffuser. Ordering code; **OD**.  
Tunable White (**TW**) version available on request.

# Polaris 20 Adjustable

EVO 48V Track



- 10 - Black
- 11 - White
- ◐ 17 - B/W

Polaris 20 adjustable spotlight with light body and arm in extruded aluminium inclusive of Integrated diamond faceted no-dazzle screen in thermoplastic. Integrated track adapter, compatible with different models of EVO 48V system. Custom size configuration is available in a multiple of 4 x LED (78mm).

Easy to insert and remove from the track. Versatile aiming angle tiltable vertically 90°.

Polaris 20 adjustable is available with CASAMBI and DALI control options. DALI dimmable fixtures can also be controlled by Casambi DALI Broadcast device, please see pages 58-59 for details.

For complete code ordering information, please see page 71.

#### LED Sources:

High Efficacy:  
CRI: 90 | CCT: 2700K, 3000K, 3500K, 4000K.

#### Accessories:

For more information on about EVO 48V track accessories see pages 60-65.



# Polaris 20 Adjustable

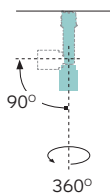
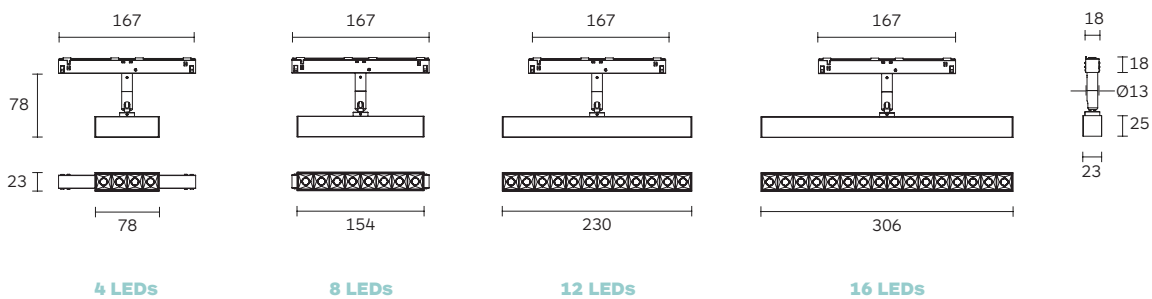

**CRI > 90**  
**3000K**

**High**  
**Efficacy**

Polaris 20 Adjustable with 4 LEDs

Product  
Code

LED Source  
Code

LED  
Power

Nominal  
Lumen

Beam Angle

Dimming  
Options

CCT Options

**9635**

**BO11**

4x1W

520 lm

**21° / 33° / 45° /  
60° / EL**

**D0** No Dim **27** 2700K

Polaris 20 Adjustable with 8 LEDs

**9636**

8x1W

1040 lm

**DA** Dali Dim **30** 3000K

Polaris 20 Adjustable with 12 LEDs

**9637**

12x1W

1560 lm

**DC** CASAMBI **35** 3500K

Polaris 20 Adjustable with 16 LEDs

**9638**

16x1W

2080 lm

**40** 4000K

EL = Elliptical Beam. Ordering code; **EL**.

Tunable White (**TW**) version available on request.

# Filo

EVO 48V Track



- 10 - Black
- 11 - White

Filo is a technically and aesthetically innovative panel light solution, with an opal front cover, Ø200mm and merely 19 mm thick, and offers homogenous lighting with high intensity. Vertically tiltable 0°-55 and available in regular and deep recessed and pendant EVO 48V track.

Filo's custom engraving algorithm ensures 97% homogeneity of light in an aluminum protective housing and a transparent laser-processed methacrylate plate.

DALI dimmable fixtures can also be controlled by Casambi DALI Broadcast device, please see pages 58-59 for details.

For complete code ordering information, please see page 71.

#### LED Sources:

High Rendering:  
CRI: 97 | CCT: 2700K, 3000K, 3500K, 4000K.

#### Accessories:

For more information about EVO 48V track accessories see pages 60-65.

# Filo

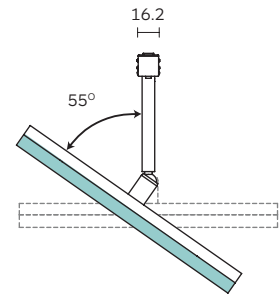
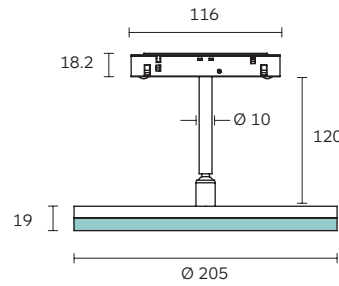
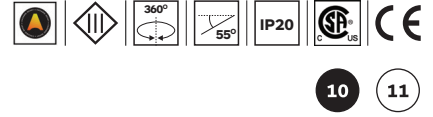

**CRI>97  
3000K**

**High  
Rendering**

Filo 200

Product Code	LED Source Code	LED Power	Nominal Lumen	Diffuser	Dimming Options	CCT Options
<b>9675</b>	<b>BR21</b>	6.5W	761 lm	<b>RD</b>	<b>DO</b> No Dim	<b>27</b> 2700K
					<b>DA</b> Dali Dim	<b>30</b> 3000K
					<b>DC</b> CASAMBI	<b>35</b> 3500K
						<b>40</b> 4000K

RD = Opal rigid diffuser. Ordering code; **RD**.

# Polaris

## EVO 48V Track Pendant

10 - Black

11 - White

17 - B/W

Pendant luminaire for EVO 48V track systems with light body in extruded aluminium inclusive of integrated diamond faceted no-dazzle screen in thermoplastic. Two standard lengths in 687mm and 915mm; custom size configuration is available in a multiple of 4 x LED (78mm).

Supplied with integrated track adapter, compatible with different models of EVO 48V track system, and 2 x 1.5m pendant wires.

Polaris EVO 48V Track Pendant is available with CASAMBI and DALI control options. DALI dimmable fixtures can also be controlled by Casambi DALI Broadcast device, please see pages 58-59 for details.

For complete code ordering information, please see page 71.

### LED Sources:

High Efficacy:  
CRI: 90 | CCT: 2700K, 3000K, 3500K, 4000K.

### Accessories:

For more information about EVO 48V track accessories see pages 60-65.



# Polaris

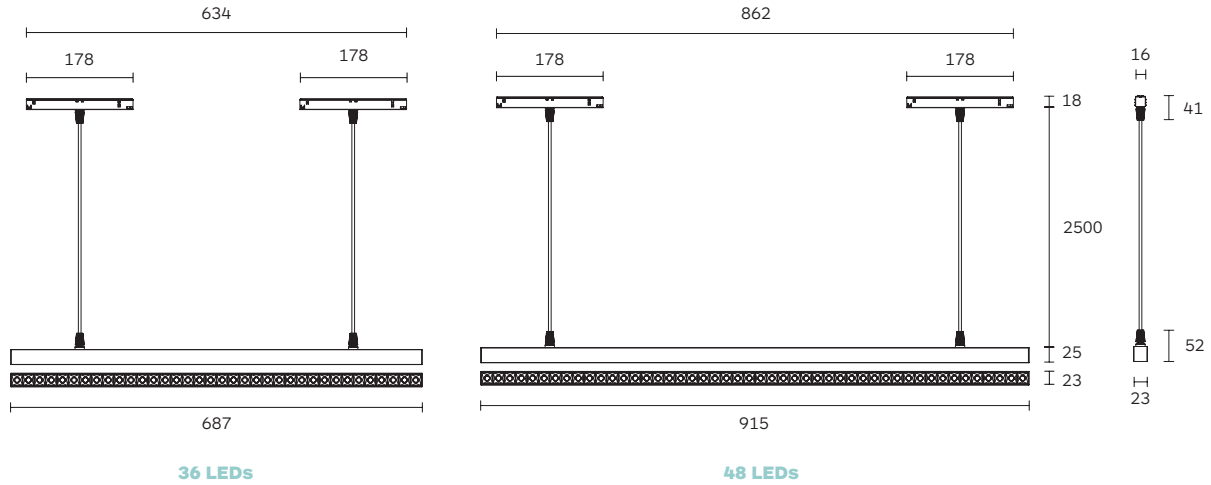
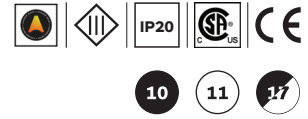

**CRI > 90**  
**3000K**

**High Efficacy**

	Product Code	LED Source Code	LED Power	Nominal Lumen	Beam Angle	Dimming Options	CCT Options
Polaris 20 Pendant with 36 LEDs	<b>9712</b>	<b>BO11</b>	36x1W	4680 lm	<b>21° / 33° / 45° / 60° / EL</b>	<b>D0</b> No Dim	<b>27</b> 2700K
Polaris 20 Pendant with 48 LEDs	<b>9713</b>		48x1W	6240 lm		<b>DA</b> Dali Dim <b>DC</b> CASAMBI	<b>30</b> 3000K <b>35</b> 3500K <b>40</b> 4000K

EL = Elliptical Beam. Ordering code; **EL**.

# Polaris Opal Diffuser

EVO 48V Track Pendant

10 - Black

11 - White

Pendant luminaire for EVO 48V track systems with light body in extruded aluminium inclusive of white opal diffuser for soft and diffuse illumination.

Supplied with integrated track adapter, compatible with different models of EVO 48V track system, and 2 x 1.5m pendant wires.

Polaris Opal Diffuser Pendant is available with CASAMBI and DALI control options. DALI dimmable fixtures can also be controlled by Casambi DALI Broadcast device, please see pages 58-59 for details.

For complete code ordering information, please see page 71.

#### LED Sources:

High Rendering:  
CRI: 97 | CCT: 2700K, 3000K, 3500K, 4000K.

#### Accessories:

For more information about EVO 48V track accessories see pages 60-65.

# Polaris 20 Opal Diffuser

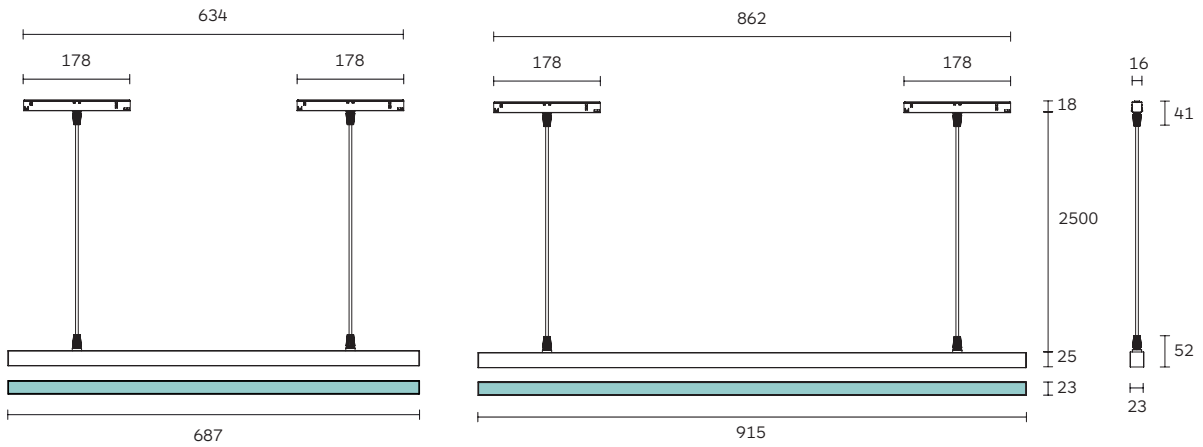

**CRI>97**  
**3000K**

**High**  
**Rendering**

	Product Code	LED Source Code	LED Power	Nominal Lumen	Diffuser	Dimming Options
Polaris 20 Opal Diffuser Pendant L:687	<b>9724</b>	<b>BT21</b>	16W	2079 lm	<b>OD</b>	<b>D0</b> No Dim
Polaris 20 Opal Diffuser Pendant L:915	<b>9726</b>		22W	2835 lm		<b>DA</b> Dali Dim <b>DC</b> CASAMBI
CCT Options						
	<b>27</b>	2700K				
	<b>30</b>	3000K				
	<b>35</b>	3500K				
	<b>40</b>	4000K				

OD = Opal diffuser. Ordering code; **OD**.

# Pixo Retro

25 | 38

EVO 48V Track

Pixo Retro offers both classic filament ambient light and modern accent light. LED filament light is designed to resemble a traditional incandescent light bulb with visible filaments for aesthetic and create ambient; the spotlight with multiple beam angle options provides functional accent lighting.

Clean product design with a clear glass body and extruded aluminum, available in two different diameters Ø25mm Ø38mm, and two different lengths.

Pixo Retro available with Casambi and DALI control options. DALI dimmable fixtures can also be controlled by Casambi DALI Broadcast device, please see pages 58-59 for details.

For complete code ordering information, please see page 71.

## LED Sources:

Ambient light:  
CRI: 80 | CCT: 2700K, 3000K, 3500K, 4000K.

Spot light:  
High Efficacy  
CRI: 90 | CCT: 2700K, 3000K, 3500K, 4000K.

## Accessories:

For more information about EVO 48V track accessories see pages 60-65.

- 10 - Black
- 65 - Embossed matt black
- 11 - White
- 54 - Embossed matt white

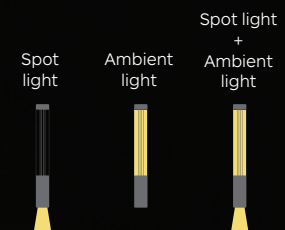



# Pixo Retro

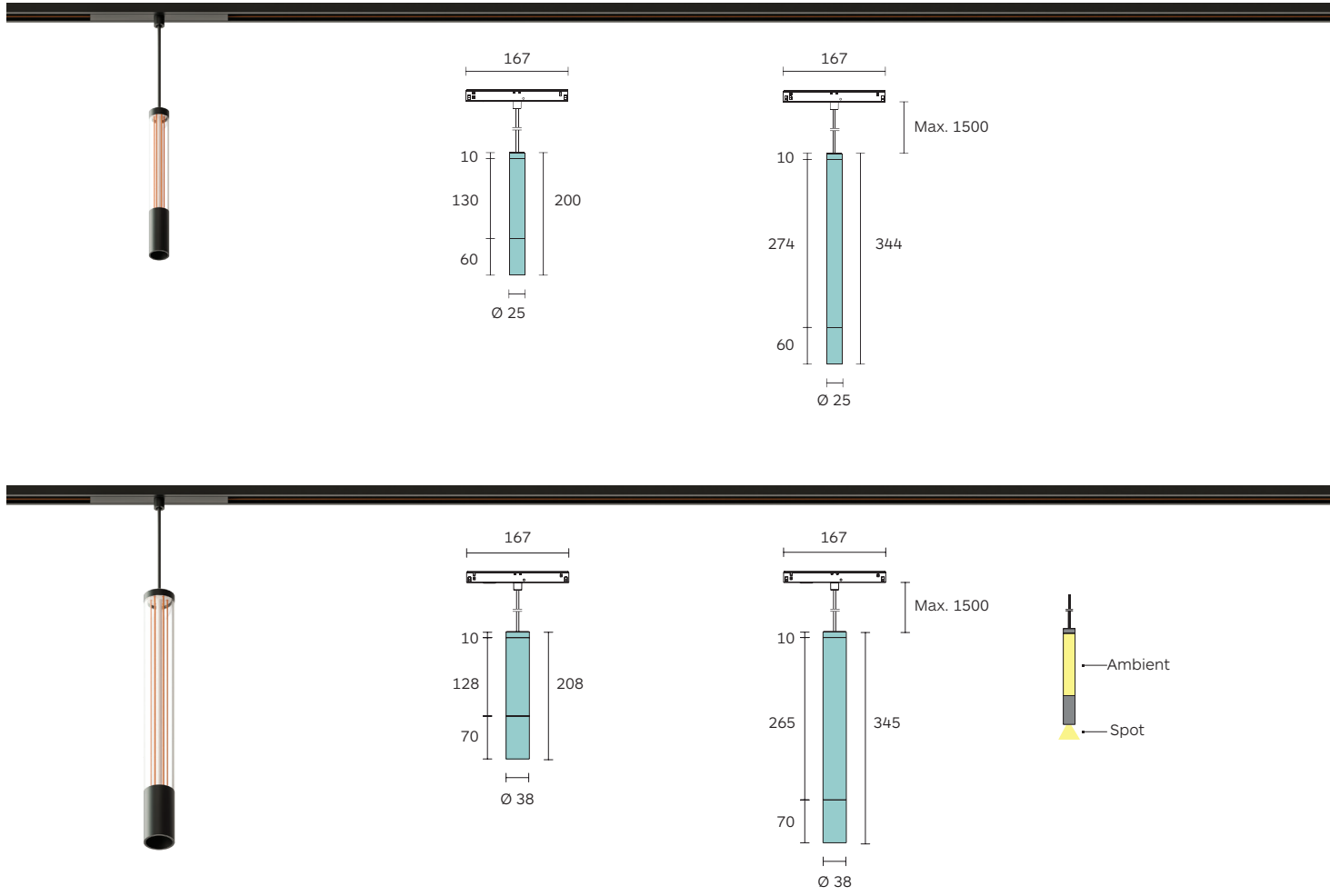

	Product Code	Length Cable Code <sup>1</sup>	LED Power <sup>2</sup>		Nominal Lumen		Beam Angle
			Ambient CRI>80	Spot CRI>90	Ambient CRI>80	Spot CRI>90	
Pixo Retro 25 L:200	<b>9656</b>	Min. <b>0100</b>	4.9W	/	397 lm	/	/
Pixo Retro 25 L:344	<b>9657</b>	⋮	/	2.6W	/	276 lm / 299 lm	<b>16° / 20° / 34°</b>
		Max. <b>1500</b>					
Pixo Retro 38 L:208	<b>9658</b>		4.9W	/	397 lm	/	/
Pixo Retro 38 L:345	<b>9659</b>		/	6.7W	/	723 lm / 780 lm	<b>20° / 25° / 34°</b>

- Dimming Options
- DA** Dali Dim
  - DC** CASAMBI
- CCT Options
- 27** 2700K
  - 30** 3000K
  - 35** 3500K
  - 40** 4000K

<sup>1</sup> Length cable code from 100mm up to 1500mm. Example: 0750.  
<sup>2</sup> 2 control channels, spot light and ambient light can be controlled separately.

# Pixo

**25 | 38**  
**EVO 48V Track**

Pendant luminaire for EVO 48V track systems with lightbody in extruded aluminum. Light body available in two sizes (Ø25 and Ø36mm) and different lengths, to fit any ceiling height.

Supplied with integrated track adapter, compatible with different models of EVO 48V track system, inclusive of 2 x 1.5m pendant wires.

DALI dimmable fixtures can also be controlled by Casambi DALI Broadcast device, please see pages 58-59 for details.

For complete code ordering information, please see page 71.

#### LED Sources:

High Efficacy:  
 CRI: 90 | CCT: 2700K, 3000K, 3500K, 4000K.

#### Accessories:

For more information about EVO 48V track accessories see pages 60-65.

- **10** - Black
- **65** - Embossed matt black
- **11** - White
- **54** - Embossed matt white



# Pixo

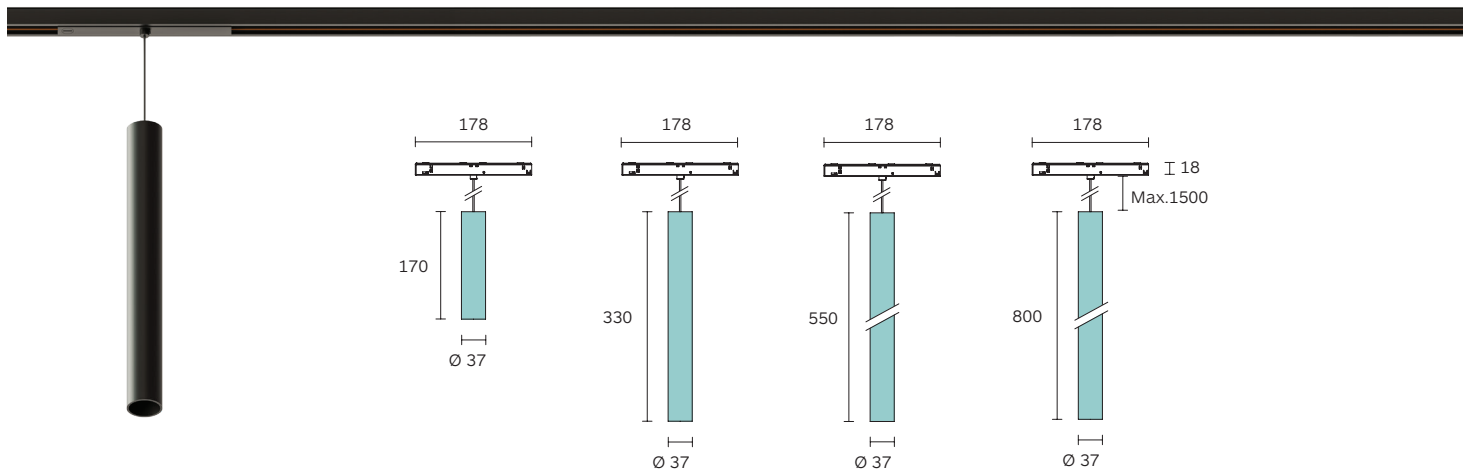
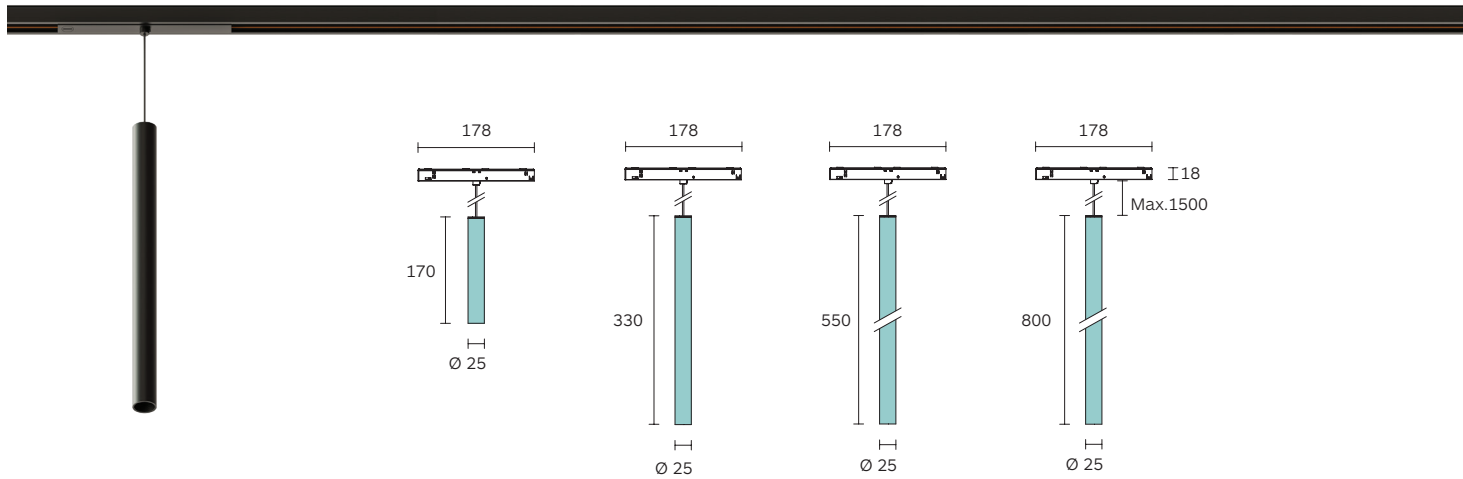

**CRI>90  
3000K**  
High  
Efficacy

	Product Code	LED Source Code	LED Power	Nominal Lumen	Beam Angle	Dimming Options
Pixo 25 L:170	<b>9703</b>	<b>BN11</b>	2W	230 lm	<b>14° / 20° / 26° / 32°</b>	<b>D0</b> No Dim
Pixo 25 L:330	<b>9704</b>					<b>DA</b> Dali Dim
Pixo 25 L:550	<b>9705</b>					<b>DC</b> CASAMBI
Pixo 25 L:800	<b>9706</b>					
	Product Code	LED Source Code	LED Power	Nominal Lumen	Beam Angle	CCT Options
Pixo 36 L:170	<b>9707</b>	<b>BC31</b>	5W	500 lm	<b>20° / 26° / 36°</b>	<b>27</b> 2700K
Pixo 36 L:330	<b>9708</b>					<b>30</b> 3000K
Pixo 36 L:550	<b>9709</b>					<b>35</b> 3500K
Pixo 36 L:800	<b>9710</b>					<b>40</b> 4000K

# Lucciole

## EVO 48V Track

The Lucciole series for EVO 48V track offers a classic & elegant Italian-designed pendant mounted decorative lighting system. It features integrated track adapter, mounts the decorative lamp using suspension cables of length 1500mm (max) with a very easy installation process.

Inspired by a firefly's ability of natural glow, it features suspension lamps of various shapes, sizes, and designs. An eco-friendly and 100% recyclable lamp with diffused light distribution.

DALI dimmable fixtures can also be controlled by Casambi DALI Broadcast device, please see pages 58-59 for details.

For complete code ordering information, please see page 71.

### LED Sources:

High Efficacy:

CRI: 90 | CCT: 2700K, 3000K, 3500K, 4000K.

### Accessories:

For more information about EVO 48V track accessories see pages 60-65.

● 10 - Black

● 11 - White



# Lucciole

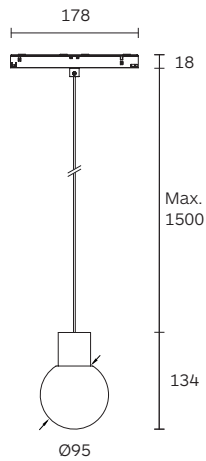

9719

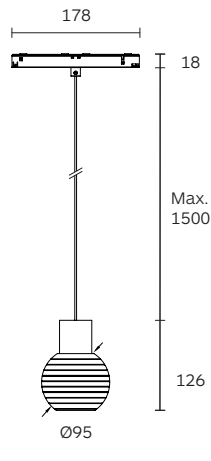

9720

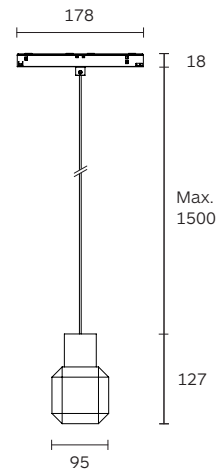

9725

CRI > 90  
3000K

High  
Efficacy

	Product Code	LED Source Code	LED Power	Nominal Lumen	Diffuser	Dimming Options	CCT Options
Lucciole	<b>9719</b>	<b>BB32</b>	6.5W	724 lm	<b>TD</b>	<b>DC</b> CASAMBI	<b>27</b> 2700K
Lucciole	<b>9720</b>					<b>DN</b> On-board Dimmer	<b>30</b> 3000K
Lucciole	<b>9725</b>						<b>35</b> 3500K
							<b>40</b> 4000K
							<b>DW</b> 3000K-1800K

TD = Transparent lenticular diffuser. Ordering code; **TD**.

# Optical Accessories

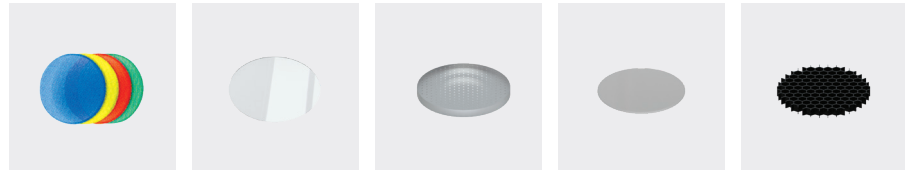

Product / Optical Accessories	Coloured Glasses Diffuser	Opal Lens	Spread Lens	Elliptical Beam Diffuser	Wide Texture Honeycomb Louvre
	25, 42, 55, 85	Colour 41	Colour 41	Colour 41	Colour 10
TicTok 25 & Vivo 25	<b>2G57</b>	<b>2G59</b>	/	<b>2G61</b>	<b>2G30</b>
TicTok 35 & Vivo 35	<b>2G58</b>	<b>2G60</b>	/	<b>2G62</b>	<b>2G31</b>
TicTok 45 <sup>1</sup> & Vivo 45	<b>2F91</b>	<b>2F94</b>	<b>2F97</b>	<b>2F88</b>	<b>2F71</b>
TicTok 58 <sup>1</sup> & Vivo 58	<b>2F92</b>	<b>2F95</b>	<b>2F98</b>	<b>2F89</b>	<b>2F83</b>
TicTok 75 & Vivo 75	<b>2F93</b>	<b>2F96</b>	<b>2F99</b>	<b>2F90</b>	<b>2F84</b>



Product / Optical Accessories	Dense Texture Honeycomb Louvre	Cross blade Louvre	Barn Doors	Wallwasher Cone 45°
	Colour 10	Colours 10, 17	Colours 10, 11	Colours 10, 17
TicTok 25 & Vivo 25	<b>2G32</b>	/	/	/
TicTok 35 & Vivo 35	<b>2G33</b>	/	/	/
TicTok 45 <sup>1</sup> & Vivo 45	<b>2F85</b>	<b>2G01</b>	<b>2G04</b>	<b>2G07</b>
TicTok 58 <sup>1</sup> & Vivo 58	<b>2F86</b>	<b>2G02</b>	<b>2G05</b>	<b>2G08</b>
TicTok 75 & Vivo 75	<b>2F87</b>	<b>2G03</b>	<b>2G06</b>	<b>2G09</b>

## Notes:

<sup>1</sup> No optical accessories are available for TicTok 45, 58 Zoom series.

# Optical Accessories

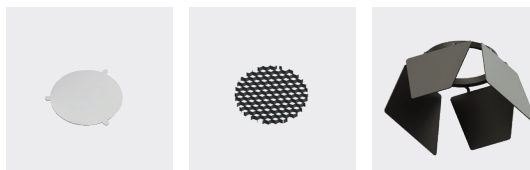

Product /  
Optical Accessories

Filter

Honeycomb

Barn Doors

Colour 10

Colours 10, 11

Zero 33

**G2A6**

**G2A7**

**G2A1**

Zero 33 Long Arm



Product / Optical Accessories

Coloured Filters

Linear Spread

Honeycomb Louvre

Visor

Anti-glare Tube

Colours 25, 42, 55, 85

Colour 41

Colour 10

Colours 10, 17

Colours 10, 17

Zero 40 & Zero 40 with Long Arm

**2E36\***

**2E44\***

**2E35**

/

**2E43**

Zero 66 & Zero 66 with Long Arm

**2D63\***

**2D62\***

**2C65**

**2D94**

**2D67**

Zero 100 & Zero 100 with Long Arm

**2E10\***

**2E12\***

**2C66**

**2E14**

**2E16**



Product /  
Optical Accessories

Gobo film

Colour 10

Zero Framing Projector 38

**2G24**

## Notes:

\* With holder

# TicTok & Vivo

The circular series













TicTok provides innovation leadership with the new Eterno technology. The easy to change COB module provides a ready-to-use solution for greater flexibility, energy efficiency, and sustainability.



# LED Modules & Lens compatibility

For TikTok & Vivo products

Product compatibility	LED Module	CRI	LED Power	LENS Compatibility Code						
				15°	20°	32°				
<b>TicTok 25</b> Codes: 96B2   96C3	<b>E017</b>		3.4W	L021	L022	L023				
<b>Vivo 25</b> Codes: 96A8   96C8										
<b>TicTok 35</b> Codes: 96B3   96C4	<b>E013</b>		5W	L024	L025	L026				
<b>Vivo 35</b> Codes: 96A9   96C9										
<b>TicTok 45</b> Codes: 9662   9663	<b>E025</b>		9W	L014	L015	L016				
<b>Vivo 45</b> Codes: 96B0   96D0	<b>E020</b>		9W	L014	L015	L016				
<b>TicTok 58</b> Codes: 9664   9665	<b>E026</b>		14W	/	L017	/	L018	/	L019	
<b>Vivo 58</b> Codes: 96B1   96D1	<b>E031</b>		15W	L017	/	L018	/	L019	/	
	<b>E027</b>		14W	/	L017	/	L018	/	L019	
<b>TicTok 75</b> Codes: 9666   9667	<b>E029</b>		18W	L008	/	L009	L010	/		
<b>Vivo 75</b> Codes: 96C7   96D2	<b>E006</b>		18W	/	L008	L009	/	L010		
<b>TicTok 45 Zoom</b> Codes: 96A6   96C5	<b>E009</b>		6W				2G63			
<b>TicTok 58 Zoom</b> Codes: 96A7   96C6	<b>E004</b>		15W				2G64			

# Casambi DALI Broadcast



# Casambi DALI Broadcast

## For EVO track 48VDC input

Casambi DALI Broadcast offers a cutting-edge solution for controlling wireless luminaires on low-voltage (48V) tracks.

Through Casambi Bluetooth Low Energy (BLE) communication with control apps, all you need is a smartphone or tablet to take charge of your lighting system.

Imagine having complete control over the lighting in your space without the hassle of wiring, control units, or routers. With Casambi Broadcast technology, this dream is now a reality.

Add a Casambi DALI broadcast device (9269) directly to EVO 48V track, and select a product with a DALI driver included (DA).

## Group Configuration - up to 64 luminaires

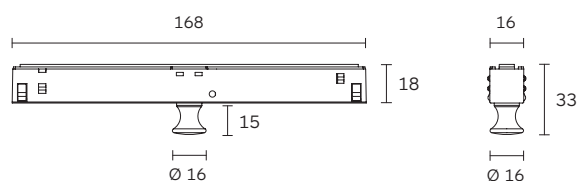
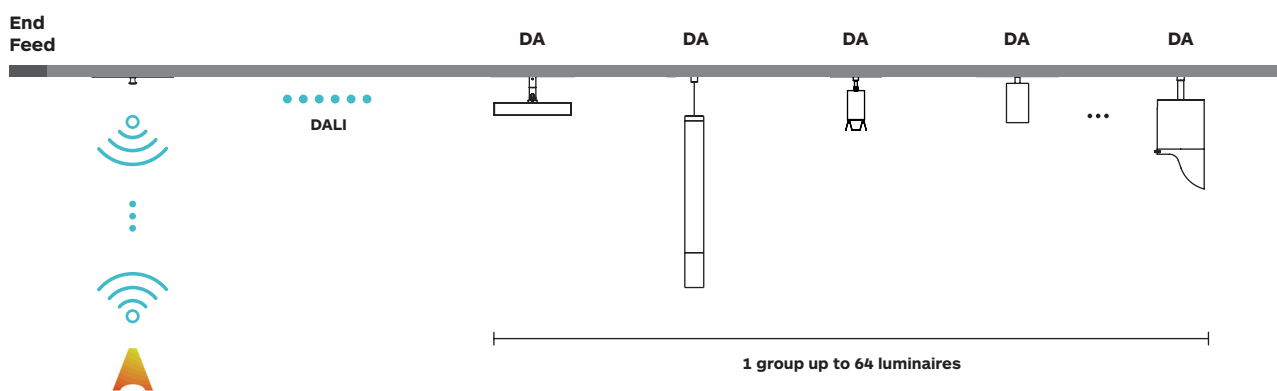

### Wireless control device

<b>Code:</b>	<b>9269</b>
Nominal Input Voltage:	24-50 Vdc
Current:	48V - 0.06 A
Output Voltage:	18 - 18.5 V DC
Output current in short circuit:	200 mA
Output channel:	1
Management protocol:	DALI

# EVO 48V Track Options

## Recessed Trim Track

2ST8 + Art. 9202 Bracket with spring for 2ST8 included

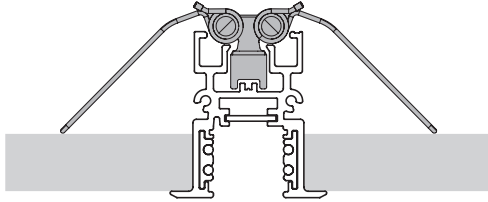

## Recessed Trimless Track

2ST3 + Art. 9201 Bracket for 2ST3 trimless track included

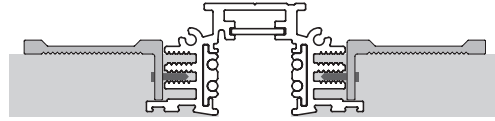

## Deep Recessed Trimless Track

2STA

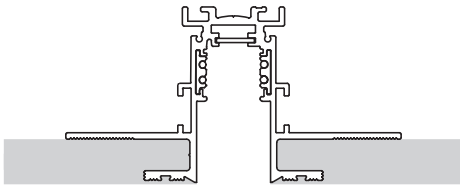

## Deep Recessed Trimless Track

2ST5

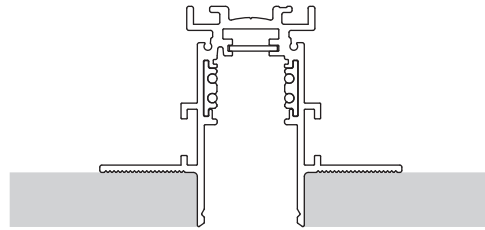

## Pendant Track

2ST6 +  
Pendant  
Kits  
Art.9226

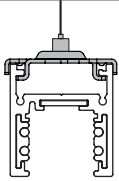

2ST2 +  
Deep  
Pendant  
Kits  
Art.9226

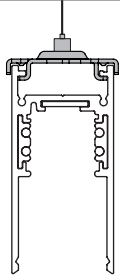

2ST7 +  
Pendant  
Kits  
Art.9226

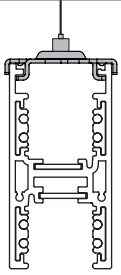

2ST9 +  
Deep  
Pendant  
Kits  
Art.9226

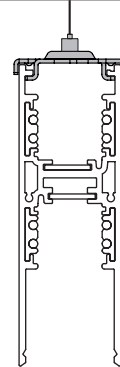

## Pendant Kit

Pendant  
Kit  
Art. 9226

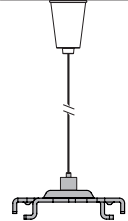

## Surface Track

2ST6 +  
Surface  
Kits  
Art.9225

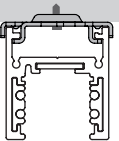

2ST2 +  
Deep  
Surface  
Kits  
Art.9225

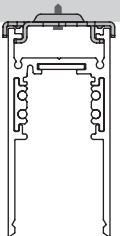

2ST1

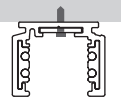







## Surface Kit

Surface  
Kit  
Art. 9225



# Compatibility

Track Options/ Product name									
	2ST1	2ST6	2ST2	2ST7	2ST9	2ST8	2ST3	2ST5	2STA
TicTok & Vivo 25 / 35 / 45 / 58 / 75	✓	✓		✓ Up & Down	✓ Up & Down	✓	✓		
TicTok & Vivo <b>Long Arm</b> 25 / 35 / 45 / 58 / 75	✓	✓	✓	✓ Up & Down	✓ Up & Down	✓	✓	✓	✓
TicTok <b>Zoom</b> 45 / 58	✓	✓		✓ Up & Down	✓ Up & Down	✓	✓		
TicTok <b>Zoom</b> 45 / 58 <b>Long Arm</b>	✓	✓	✓	✓ Up & Down	✓ Up & Down	✓	✓	✓	✓
Zero Framing Projector Zero Compasso Wallwasher Zero 33 / 40 / 66 / 100 Zero <b>Zoom</b> 80	✓	✓		✓ Up & Down	✓ Up & Down	✓	✓		
Zero Framing Projector Zero 33 / 40 / 66 / 100 Zero <b>Zoom</b> 80 <b>Long Arm</b>	✓	✓	✓	✓ Up & Down	✓ Up & Down	✓	✓	✓	✓
Polaris 20 Polaris 20 Wallwasher Polaris 20 Opal Diffuser	✓	✓	✓	✓ Up & Down	✓ Up & Down	✓	✓	✓	✓
Polaris 20 Adjustable	✓	✓	✓	✓ Up & Down	✓ Up & Down	✓	✓	✓	✓
Filo	✓	✓	✓	✓ Up & Down	✓ Up & Down	✓	✓	✓	✓
Polaris 20 Polaris 20 Opal Diffuser Pendant	✓	✓	✓	✓ Up & Down	✓ Up & Down	✓	✓	✓	✓
Pixo Retro 25 & 38 Pixo 25 & 36 Pendant	✓	✓	✓	✓ Up & Down	✓ Up & Down	✓	✓	✓	✓
Lucciole Pendant	✓	✓	✓	✓ Up & Down	✓ Up & Down	✓	✓	✓	✓

# Mounting Accessories

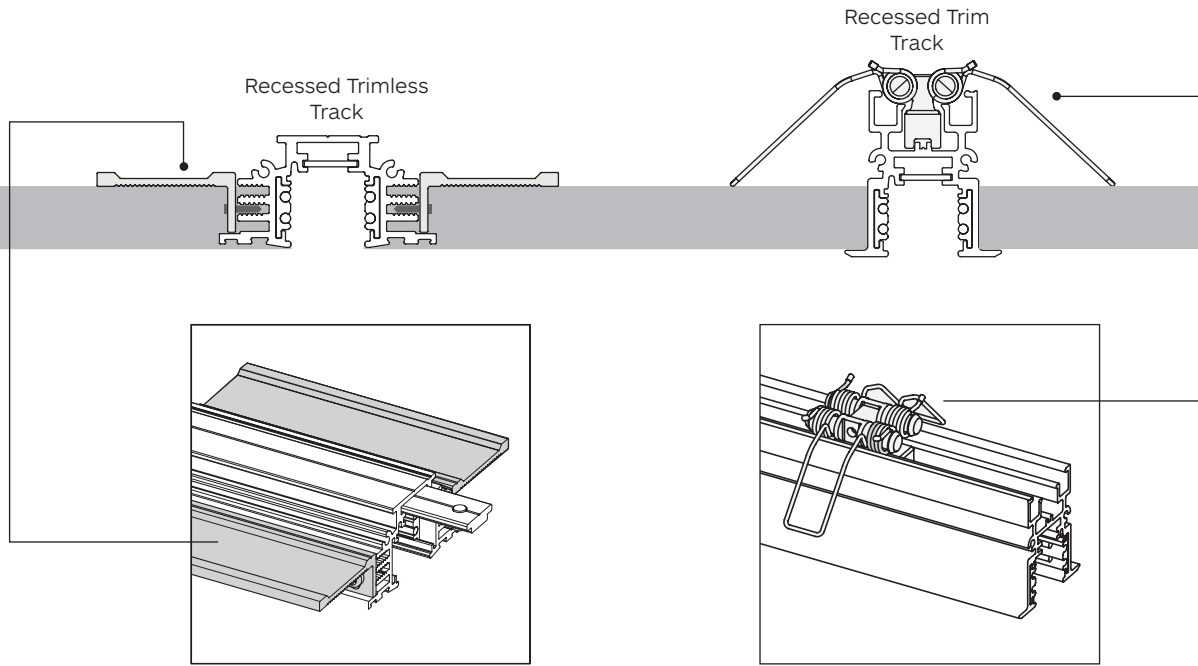

Bracket for 2ST3 Trimless Track  
**Art. 9201**

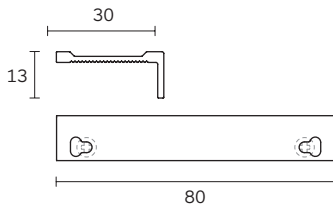

Bracket with Spring for 2ST8  
**Art. 9202**

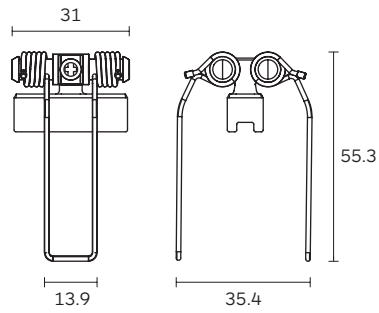

# EVO 48V Track

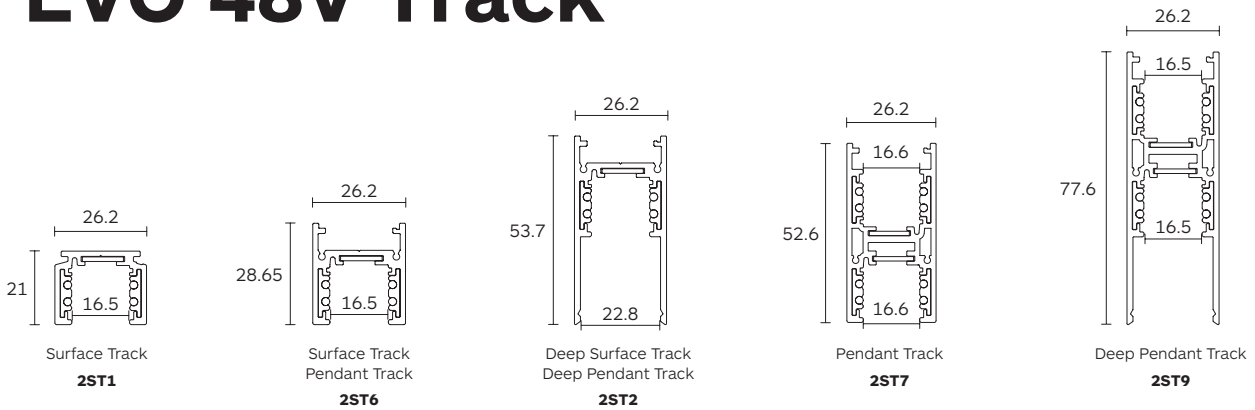

# Mounting Accessories

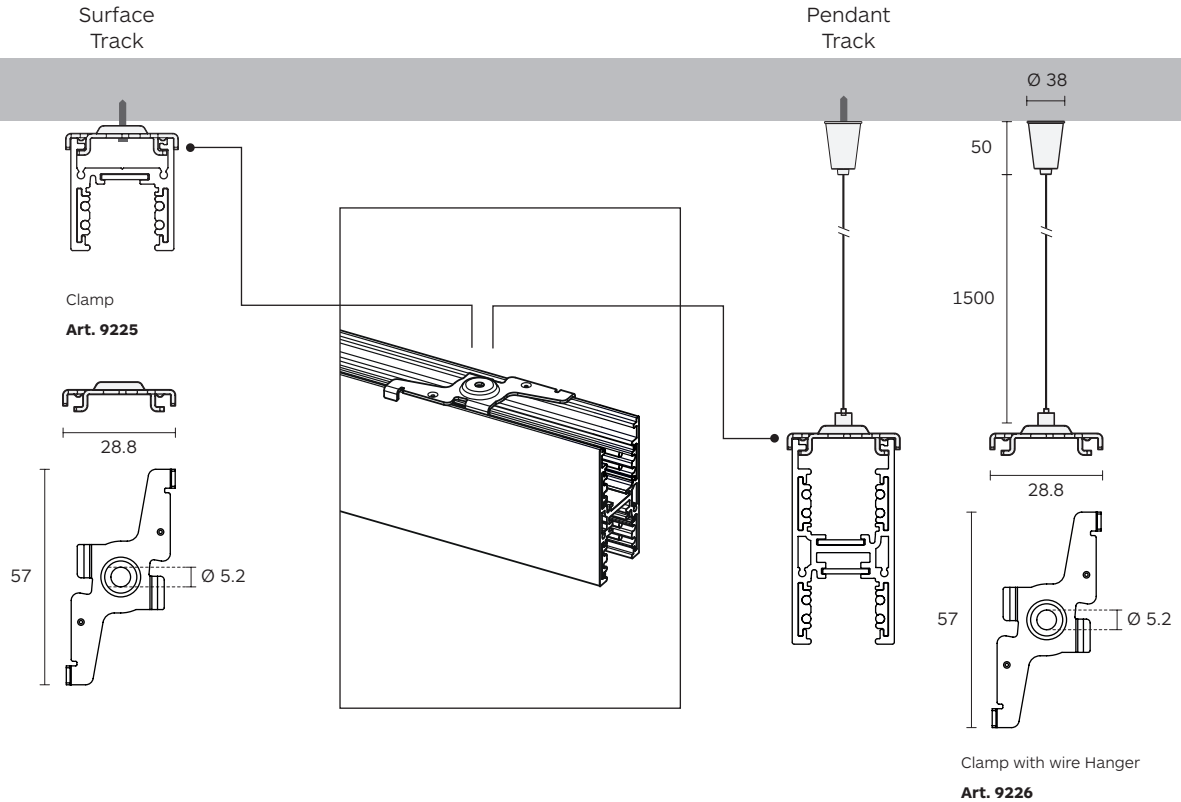

## EVO 48V Track

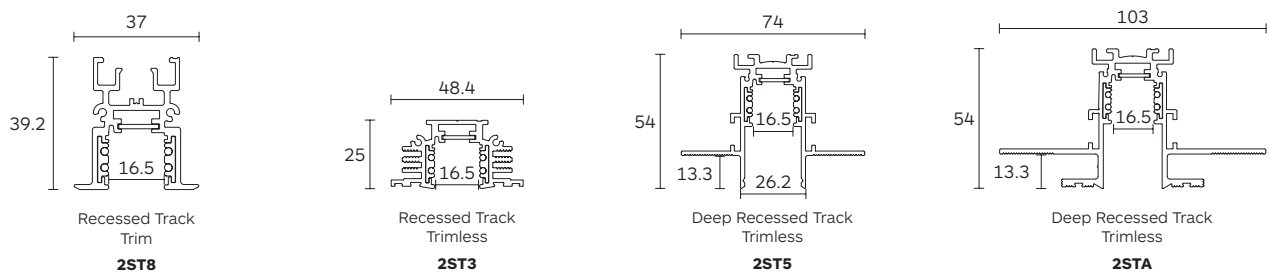

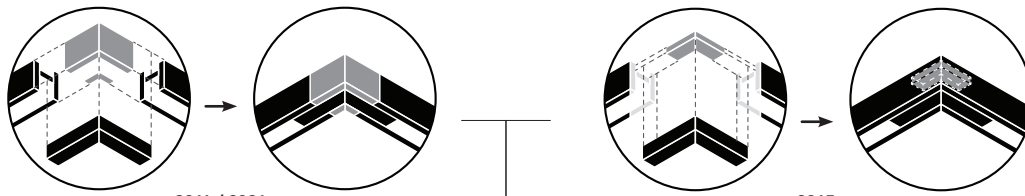

**9214 / 9231**  
Cover for L Joint  
(For 2ST2 / 2ST6)

**9215**  
L Bracket for angles

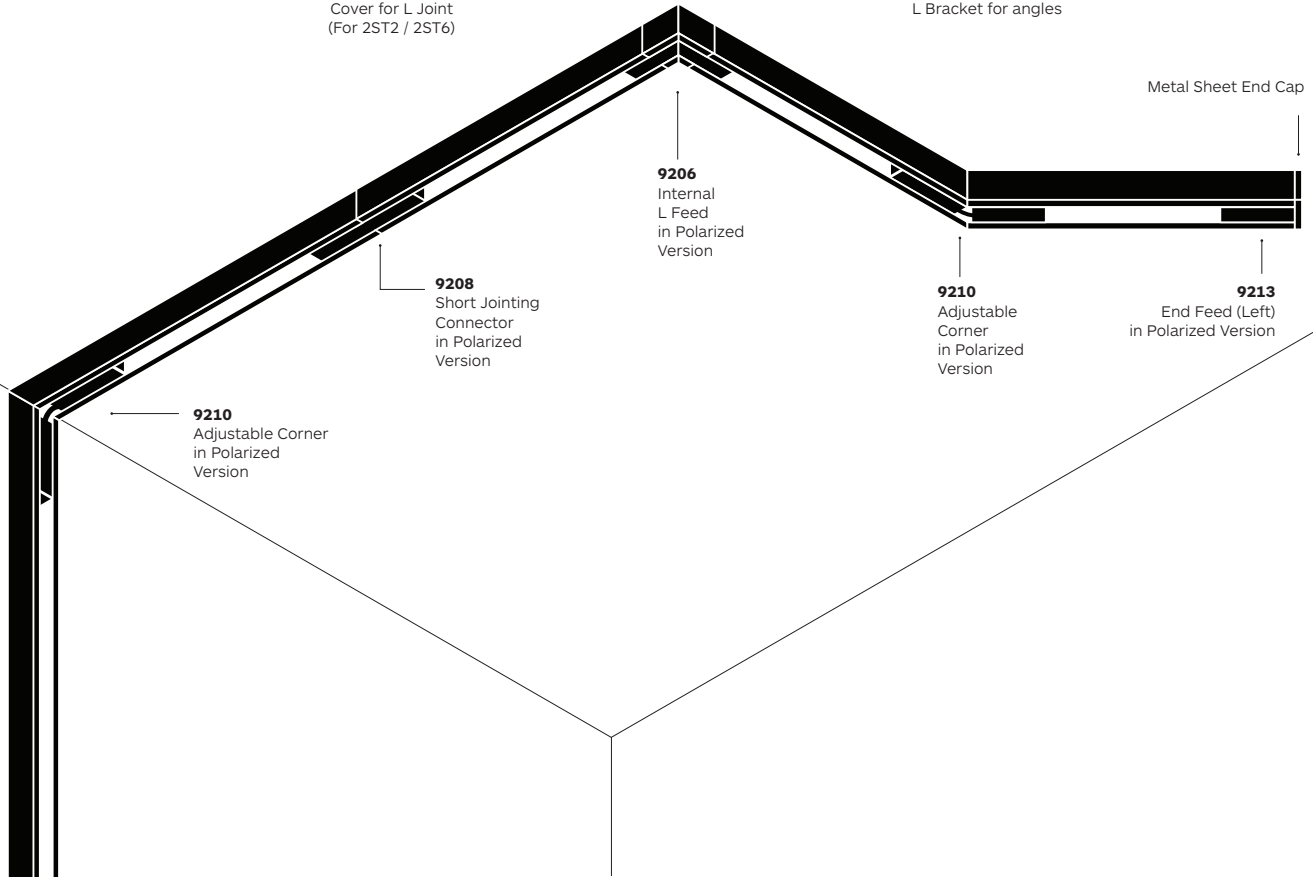

**Reference Diagram for Choice of Connectors**

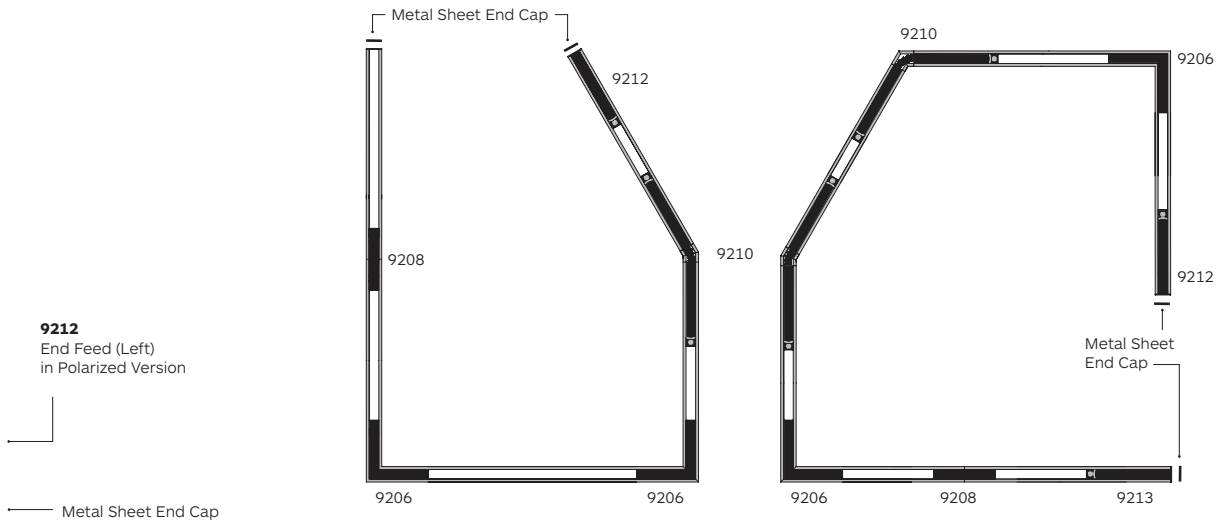



# Installation Components for EVO 48V Track

**9201** Bracket for 2ST3 trimless track

**9225** Clamp

**9202** Bracket with spring for 2ST8

**9226** Clamp with Wire Hanger

## Accessories

**9206\*** Interl L feed in Polarized Version

**9208\*** Short Jointing connector in Polarized Version

**9210\*** Adjustable corner in Polarized Version

**9212\*** End Feed (Left) in Polarized Version  
**9213\*** End Feed (Right) in Polarized Version

**9214\*** Cover for L Joint (For 2ST2)

**9231** Cover for L Joint (For 2ST6)

**9215** L Bracket for angles (For 2ST2, 2ST6)

**2G54** L-bracket (For 2ST3, 2ST5, 2STA & 2ST8)

**9216\*** Metal sheet End Cap for 2ST1  
**9217\*** Metal sheet End Cap with hole for 2ST1

**9221\*** Metal sheet End Cap for 2ST6  
**9222\*** Metal sheet End Cap with hole for 2ST6

**9218\*** Metal sheet End Cap for 2ST2, 2ST5 & 2STA  
**9219\*** Metal sheet End Cap with hole for 2ST2, 2ST5 & 2STA

**9230\*** Metal sheet End Cap for 2ST7  
**9224\*** Metal sheet End Cap for 2ST9

**9223\*** Metal sheet End Cap for 2ST8

**9220\*** Metal sheet End Cap for 2ST3

**9227\*** Reinforcing Bracket for Jointing Connector with Track 2ST3, 2ST5, 2ST8, 2STA

**9234** Bracket for Jointing Connector with Track 2ST2, 2ST6, 2ST8

**Notes:**

- \* Available in colours 10, 11.
- \*\* Available in colours 10, 11, 54, 65.

# Power Supply & Control Options

## Power Supply



220-240VAC input, 48VDC output 75w power supply for EVO 48V LV track

220-240VAC input, 48VDC output 150w power supply for EVO 48V LV track

220-240VAC input, 48VDC output 100W power supply for EVO 48V LV track

220-240VAC input, 48VDC output 200W power supply for EVO 48V LV track

220-240VAC input, 48VDC output 100W power supply for EVO 48V LV track deep recessed

Code	2E28	2E29	2F07	2F08	2F09
Size	100 x 235 x 31	100 x 235 x 31	23 x 225	23 x 315	38 x 225

## Universal DALI

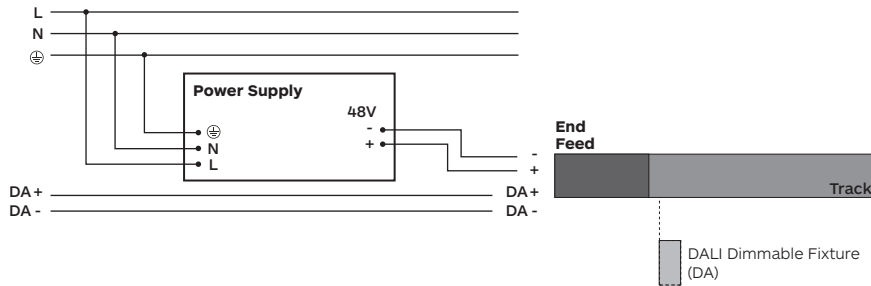

## Bluetooth wireless Control

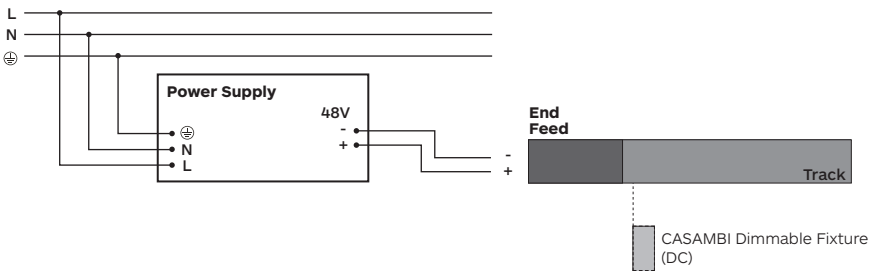

## Fixed Output

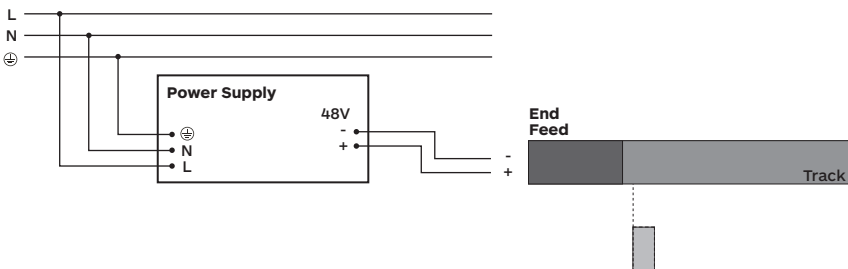

# Drop Voltage Table

<b>A</b> Distance power supply/feed unit (2x1.5mm <sup>2</sup> )				
	5m	10m	20m	30m
<b>B</b> Track Length with $\Delta v \leq 5.5\%$ (m)				
Power Supply (W)	(m)	(m)	(m)	(m)
60	50	50	50	50
100	50	50	40	25
150	50	40	20	Not admitted
200	40	30	Not admitted	Not admitted
250	35	20	Not admitted	Not admitted

Information refers to a load equivalent to the power supplied and equally distributed on the relevant length in the table.

## Remote Power Supply

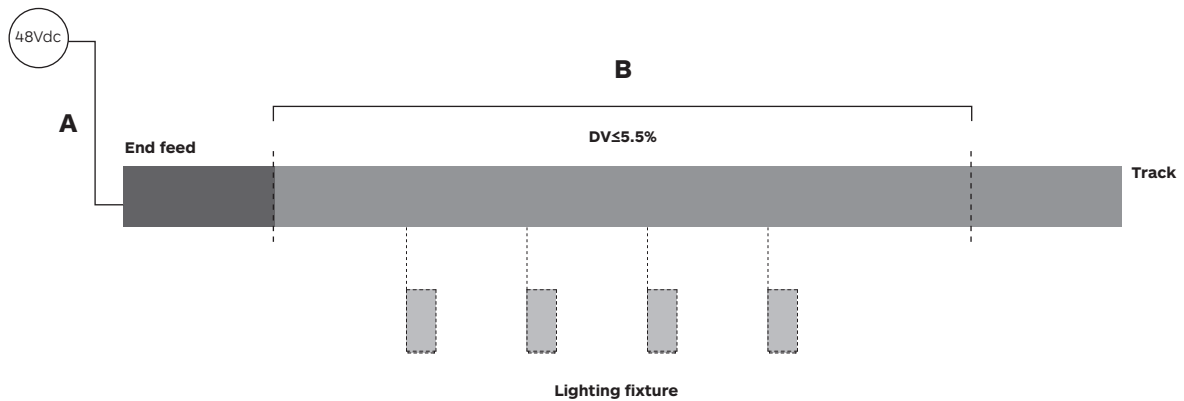



# **Symbols & Icons**

## **Code system**

### **Global presence**

## Symbols & Icons

CE Mark - Product complies with CE Standard.



CSA Mark - Product complies with USA & Canada Standard.



### Other third party product approvals

Our products include electrical and electronic components that carry other world wide Test House approvals such as those shown:



### CLASS I

Luminaires of insulation Class I - with earth connector.



### CLASS II

Luminaires of insulation Class II - With safety isolation, this means the tension conduction element are protected by additional isolation.

The isolation of an earth wire it is not necessary and the connection to it is not allowed.



### CLASS III

Luminaires of insulation Class III - designed for operation of protected low voltage supply (>42V).



Zoom



Passes the 850° glow wire test in accordance with IEC 695-2-1.



Passes the 960° glow wire test in accordance with IEC 695-2-1.



Dim2Warm



Tuneable White



CASAMBI



Recyclable



## LEDs in formalighting Luminaires

Lumenetix

Citizen

Cree

Luminus

Osram

Nichia

## IP\_\_ Degree of Ingress Protection IP\_\_

1st Number	Protection Against Dust and Solid Objects	2nd Number	Protection Against Moisture and Liquids
0	No-Protection	0	No-Protection
1	Protection against solid objects >50 mm	1	Protection against dripping water
2	Protection against solid objects >12 mm	2	Protection against dripping water tilted > 15 deg
3	Protection against solid objects >2.5 mm	3	Protection against spraying water > 30 deg
4	Protection against solid objects >1 mm	4	Protection against spraying water
5	Dust - protected	5	Protection against water jet
6	Dust - tight	6	Protection against waves
		7	Protection against the effects of immersion
		8	Protection against submersion

## Body Color

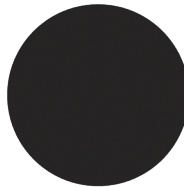

10 Black (RAL 9004)



65 Embossed matt black (RAL 9017)



11 White (RAL 9003)



54 Embossed matt white (RAL 9016)



\*17 Black (RAL 9004) / White (RAL 9003 (B&W))

# Code System

Code ordering example: **9 6 6 6 E 0 0 6 - 9 8 3 0 1 4 D 0 1 0**

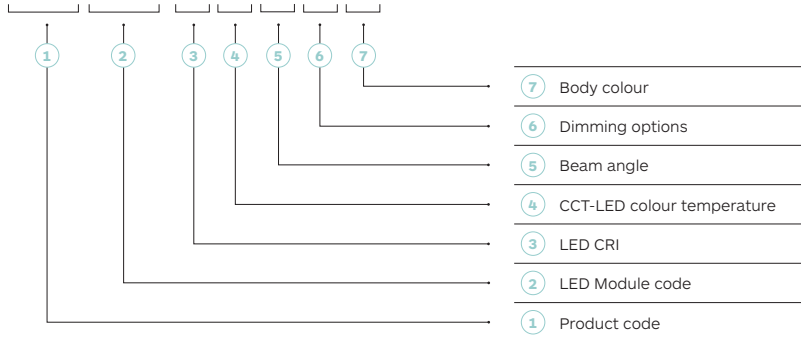

LED CRI	CCT-LED Colour temperature	Dimming Options	Body Colour
<b>90</b> CRI > 90	<b>27</b> Warm White 2700K	<b>D0</b> No dimming	<b>10</b> Black (RAL 9004)
<b>93</b> CRI > 93	<b>30</b> Warm White 3000K	<b>DA</b> Dali Dim	<b>11</b> White (RAL 9003)
<b>98</b> CRI > 98	<b>35</b> Warm White 3500K	<b>DC</b> CASAMBI	<b>*17</b> Black (RAL 9004) / White (RAL 9003 (B&W))
	<b>40</b> Neutral White 4000K	<b>DN</b> On-board Dimmer	<b>54</b> Embossed matt white (RAL 9016)
			<b>65</b> Embossed matt black (RAL 9017)

**Notes:**

\*17: white light body with black integrated louvre. For black body with white integrated louvre consult us.

# How to order

	Product Code	LED Module Code	LED Power	Nominal Lumen	Beam Angle
TicTok 45	<b>9662</b>	<b>E020</b>	9W	901 lm	<b>18° / 28° / 36°</b>
TicTok 58	<b>9664</b>	<b>E027</b>	14W	1458 lm	<b>18° / 25° / 37°</b>
TicTok 75	<b>9666</b>	<b>E006</b>	18W	1765 lm	<b>14° / 26° / 37°</b>

Attribute	Value
1 Product code	<b>9666</b>
2 LED Module code	<b>E006</b>
3 LED CRI	<b>98</b>
4 CCT-LED colour temperature	<b>30</b>
5 Beam angle	<b>14</b>
6 Dimming options	<b>D0</b>
7 Body colour	<b>54</b>

Dimming Options	CCT Options
<b>D0</b> No Dim	<b>27</b> 2700K
<b>DA</b> Dali Dim	<b>30</b> 3000K
<b>DC</b> CASAMBI	<b>35</b> 3500K
<b>DN</b> On-board Dimmer	<b>40</b> 4000K

# Global presence

Celebrating over 50 years of vision, dedication and innovation, formalighting's versatile and high-quality product offerings extends internationally via our headquarters in Hong Kong, London, Milan and Shanghai.

Our well chosen and selected partners as well as our affiliated international offices broaden our global presence further in markets such as USA, Australia, Japan, South East Asia, India and the Middle East.

Through our commitment to growth and investment within formalighting's professional team, infrastructure and product ranges, we are able to provide increasing service to our global retail and hospitality clients as well as lighting designers and specifiers strengthening our position as a leading international supplier of innovative architectural lighting solutions and systems.

With over 50 years' experience in designing and manufacturing architectural lighting, formalighting's comprehensive portfolio offers a competitive range of European designed and expertly engineered products that carry CB, CE, CCC and UL certifications.

Furthermore formalighting's latest award-winning motorized range of track, pendant, and recessed fixtures, featuring remote-controlled adjustable pan and tilt, dim, dim to warm, tuneable white and beam shaping lens, are available worldwide incorporating the latest, most advanced lighting technologies.

# Headquarters

## Europe / Milan

Tel ( +39 ) 02 9354 0300

Fax ( +39 ) 02 9343 5117

E- mail [formaitalia@formalighting.it](mailto:formaitalia@formalighting.it)

## Asia / Hong Kong

Tel ( + 852 ) 2516 6500

Fax ( + 852 ) 2516 6525

E- mail [forma@forma.com.hk](mailto:forma@forma.com.hk)

## Asia / India

Tel (+91) 9019332353

E- mail [info-india@formalighting.com](mailto:info-india@formalighting.com)



formalighting is constantly developing and improving its products therefore all information, drawings illustrations, specifications, photometric values in this catalogue are indicatives and shall not form part of any commitment by our company that reserves the right to change specifications without prior notification or public announcement.

Technical information on the installation-instruction has precedence over the information in the catalogue.

Our general terms and conditions shall apply notwithstanding any stipulation on the contrary to all the orders and agreement with formalighting. You can obtain a copy of these conditions on demand.

Publication date: October 2023  
©Copyright formalighting

With thanks to all contributors for the realization of this catalogue

Designed by formalighting's Graphic Design Department

No part of this catalogue may be copied without written authorization of formalighting

[www.formalighting.com](http://www.formalighting.com)

**formalighting**



# formalighting

HONG KONG

-

LONDON

-

MILAN

-

SHANGHAI

-

USA